

**COMMERCIAL VALVE SOLUTIONS**

***Pegler***





Pegler Yorkshire

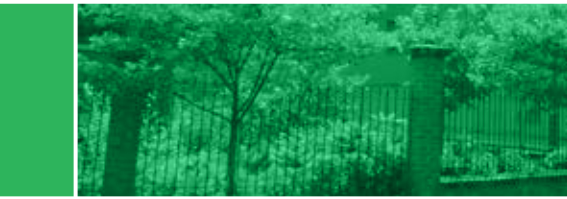

# CONNECT WITH CONFIDENCE

Diverse industry expertise combined with cutting-edge technological innovation mean Pegler Yorkshire's Control solutions help you overcome unique challenges and meet the highest standards in both performance and system aesthetics.

## PERFORMANCE WITH PRECISION

Pegler Yorkshire's **Control** products enable you to balance precision flow control, energy efficiency and comfort through innovative products and systems that ensure building performance criteria are met and the resulting installation is easy, efficient and economical to operate.

Our comprehensive **Terrier**, **Meibes** and **Ballorex** product ranges offer proven energy saving solutions, exceptional accuracy and optimised system performance - so, whatever your project or challenge, you can be sure you'll always be in control.

## GLOBAL EXPERIENCE, COMBINED EXPERTISE

With over 100 years of manufacturing and innovation combined with extensive industry knowledge and worldwide market experience, Pegler Yorkshire offers the most advanced and complete **Connect & Control** systems on a global scale.

As one of Britain's largest and most respected manufacturers and suppliers of products for the plumbing and heating industries, Pegler Yorkshire is confident we can provide you with all the connection, control and support your project needs.

*For more information visit*  
[www.pegler-yorkshire.co.uk](http://www.pegler-yorkshire.co.uk)

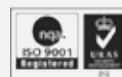





# Pegler

CONNECT + CONTROL

## CONTENTS

Pegler Yorkshire is pleased to be associated with several influential industry organisations:



Association of Plumbing and Heating Contractors



The Bathroom Manufacturers Association



The UK Copper Board



Heating and Ventilating Contractors Association



The Brass Page for specifiers, designers, engineers and manufacturers



British Plumbing Employers Council



British Electrotechnical Allied Manufacturers Association



Construction Products Association



The Copper Development Association



Scottish and Northern Ireland Plumbing Employers Federation



Builders Merchants Federation



Institute of Plumbing



The UK District Energy Association



The Chartered Institution of Building Services Engineers



British Automatic Fire Sprinkler Association



Bundesverband Technischer Brandschutz e.V.



European Fire Sprinkler Network



Water Regulations Advisory Scheme

### 1.0 PRODUCT RANGE OVERVIEW

Connection types	4
Range type	6

### 2.0 PRODUCT RANGE DETAILS

Pegler Tectite push-fit valves	10
Pegler XPress press-fit valves	18
Pegler valves Henco with multi-layer connection	29
Threaded valves	37
Compression end valves	59
Accessories	70
Flanged valves	74
Weld valves	80

### 3.0 TECHNICAL DATA

Pressure and temperature ratings	82
Technical suitability	92
Materials specification	97
Pressure equipment directive (PED)	108
Flange tables	116
Connection instructions	118



## PRODUCT OVERVIEW

Pegler Yorkshire has been a major force in valves and fittings for over 100 years and our commercial valves package is built upon the unique strengths in design and manufacture accumulated over this period.

As well as offering traditional threaded and compression connections the Pegler commercial valves range also offers the new connection technology of press-fit and push-fit jointing and sets a new standard for the industry. When pipe sizing reaches 2" sizes and above, particular consideration should be given to material selection.

The Pegler commercial valves package also offers cast iron and steel valves in a range of types and sizes. Steel valve applications are focused on district heating but also form part of the Pegler commercial package with flanged and welded end valves being available.

## END CONNECTIONS OVERVIEW

### TECTITE PUSH-FIT CONNECTIONS

A fast, cost effective jointing system ideal for copper and steel (stainless and carbon), with joints created in seconds without complex clamping, the application of heat and extended preparation and adhesive curing delays.

#### FEATURES

- ✚ Major time savings
- ✚ Permits rapid installation and removal (if required)
- ✚ No special tools required
- ✚ Heat-free for enhanced safety, with no localised annealing
- ✚ No carbon deposits, reduced corrosion risk
- ✚ Perfectly clean internal bore, less finishing/cleaning
- ✚ Valves available in Bronze, Duplex Brass and DZR to suit operating duty



### XPRESS PRESS-FIT CONNECTIONS

A quick, clean, heat-free jointing technology for copper, stainless steel and carbon steel pipe work up to 54mm. Unique 'Leak Before Press' feature on all connection sizes up to 54mm (DN50 Screwed valves).

#### FEATURES

- ✚ Unique design and using bronze permits jointing of all materials - one connector fits all
- ✚ Simple and fast, reduces time on site with good repetition of joint quality
- ✚ Uses one simple, inexpensive tool with no additional materials
- ✚ Intrinsically clean, no flushing to remove residues
- ✚ No hot works permits and associated insurance implications or health and safety hazards
- ✚ Suitable for both heating, chilled and potable water (where WRAS Approved)
- ✚ Valves available in Bronze, Duplex Brass and DZR to suit operating duty





CONNECT + CONTROL

### HENCO MULTI-LAYER VALVES

A highly innovative and cost effective system, including pipes, fittings and valves. Multi-layer pipe combines the best features from metal and plastic pipe systems. The Pegler valve range offers solutions from 16mm to 40mm connections.

#### FEATURES

- ✚ Unique design using Pegler valve assembly technology
- ✚ Union connections to each valve end offers pipe breaks up and downstream of the valve
- ✚ The range provides for insulation, regulation and back flow protection
- ✚ Simple and fast, reduces time on site with good repetition of joint quality
- ✚ No hot work permits and associated insurance implications or health and safety hazards
- ✚ Suitable for both heating, chilled and potable water (where WRAS Approved)
- ✚ Valves available in Bronze, Brass and DZR brass to suit operating duty



### THREADED CONNECTIONS

A heat free jointing method particularly suited to smaller, fixed systems using EN10255 mild steel tube, where the installation is expected to remain unchanged for long periods of time. Products are available (dependent on style) for three types of thread.

#### FEATURES

- ✚ ISO7 Rc (BS21) taper thread
- ✚ ISO 228 parallel thread
- ✚ ANSI (NPT) American taper thread
- ✚ Suitable for heating, cooling and potable water applications (where material suitability and relevant standards are applicable or WRAS Approved is required)
- ✚ Valves available in Bronze, Duplex Brass and DZR



### COMPRESSION CONNECTIONS

A traditional heat free mechanical jointing system making it easy to undo and re-make joints. Ideal for applications where maintenance and repair are required.

#### FEATURES

- ✚ Major time saving compared to soldering and brazing
- ✚ Intrinsically clean bore, less flushing/cleaning
- ✚ No hot works permits and associated insurance implications
- ✚ Suitable for heating, cooling and potable water applications (where material suitability and relevant standards are applicable or WRAS Approved is required)
- ✚ Valves available in Duplex Brass, DZR and Gunmetal
- ✚ CE Marked for compliance to Construction Products Directive





## PRODUCT OVERVIEW

### FLANGED CONNECTIONS

A robust jointing mechanism for pipe diameters of DN65 and upwards. Ideally suited to applications where pipe work is likely to be dismantled for valve maintenance/replacement. Very quick and easy to undo and re-make joints or where prefabrication is the chosen construction method.

#### FEATURES

- ✚ Valves available in Steel, Cast and Ductile Iron in gate, ball, butterfly, swing and dual plate check valves
- ✚ Suitable for heating, cooling and potable water applications (where material suitability and relevant standards are applicable)



### WELD CONNECTIONS

A high integrity, leak proof jointing method ideal for pipelines where operating temperatures and pressures determine that welding is the optimal jointing method. Ideal for systems where maintenance is not required.

#### FEATURES

- ✚ Valves available in Steel
- ✚ Available in weld prepared and extended connection piece tail styles
- ✚ Ball valves available to PN40
- ✚ Live weld in tapping kits and valves available



### RANGE TYPES

#### QUARTER TURN BALL VALVES

Compact, easy to operate, quarter turn ball valves in the Pegler Commercial range are designed for long, trouble free service. Available in lever, 'T' handle and key operated lockshield designs, they provide an ideal means of isolating a range of fluids in pipe lines.

#### FEATURES

- ✚ DN15 – DN100 size range
- ✚ PN16, PN25, PN40 pressure rated options available
- ✚ Available in Brass, Chrome Plated Brass unplated DZR
- ✚ Full bore
- ✚ Choice of push-fit, press-fit, threaded and compression connections
- ✚ Optional locking devices available
- ✚ WRAS Approval where stated
- ✚ Yellow lever versions CE Marked for compliance to Construction Products Directive







CONNECT + CONTROL

### BALLOMAX BALL VALVES

Full bore Ballomax steel ball valves are ideal for district heating systems, general heating systems and a host of industrial applications.

#### FEATURES

- + DN15 – DN400 standard size range
- + PN16, PN25, PN40 pressure rating available
- + Full welded, full bore, ball seal compensated, steel valves
- + Screwed, weld ends and flanged connections available
- + Hot (live tapping kits) available (DN15 – DN100 branch size)
- + Lever, lockshield, gearbox, manhole, electric actuation and mobile operation available



### BUTTERFLY VALVES

Butterfly valves are ideal where a slim profile, low weight isolation and throttling is required on DN65 and above pipe sizes.

#### FEATURES

- + DN65 – DN300 standard size range
- + PN16 rated
- + Fully lugged and semi-lugged options available
- + Stainless steel disc as standard
- + Lever and gearbox operation options
- + WRAS Approval where stated



### BALLOFIX ISOLATING BALL VALVES

Ballofix in-line isolation valves offer a wide range of both body styles and end connections for potable and hot and cold water, oil and compressed air and gas services.

#### FEATURES

- + DN8 – DN25 size range, 15mm to 28mm
- + PN10 rated
- + Push-fit, press-fit, threaded and compression connections available
- + Filter options available
- + DZR brass unplated and chrome plated options
- + WRAS Approved



### GATE VALVES

Optimally designed, traditional full way gate valves either in wheel head or lockshield are ideal for isolating a range of fluids in pipe lines.

#### FEATURES

- + DN15 – DN100 size range
- + Choice of push-fit, press-fit, threaded, compression and flanged connections \*where applicable
- + Brass, DZR, Bronze and Cast Iron construction materials
- + WRAS Approval where stated
- + Kite Marked where stated





## PRODUCT OVERVIEW

### GLOBE VALVES

Globe valves offer the ideal solution where control or throttling is required to control or regulate the flow of fluids in a pipe line.

#### FEATURES

- + DN8 – DN50 size range
- + PN32 rated
- + Renewable or metal disc options available
- + Bronze construction materials



### CHECK VALVES

An extensive range of non-return valves in Bronze, Brass and Cast Iron. Designs include swing, horizontal lift, dual plate and spring/foot valves.

#### FEATURES

- + DN15 – DN300 standard size range
- + PN16 ratings for flange, ratings to PN32 on thread valves
- + Choice of push-fit, press-fit, threaded, compression and flanged connections
- + Bronze, Brass, DZR and Cast Iron construction materials
- + WRAS Approved where stated



### STRAINERS

Y-pattern strainers with mesh filters provide highly effective protection from system debris causing damage to sensitive controls and valves in a pipe line.

#### FEATURES

- + DN15 – DN300 size range
- + PN16 – 32 ratings
- + Y-pattern and isolating options available
- + Choice of push-fit, press-fit, threaded and flanged connections \*where applicable
- + Stainless steel mesh as standard
- + Bronze, Brass and Cast Iron versions
- + WRAS Approved where stated







CONNECT + CONTROL

### DRAIN VALVES

Pegler drain cocks have threaded and plain tail options for connection to compression fittings. Spanner and key operated lockshield mechanisms are available. Installation applications include system draining and equipment draining for where maintenance is required.

#### FEATURES

- + Drain cocks with thread ends
- + BS2879-2
- + PN20 rated
- + 1/2", 3/4" and 1" sizes
- + WRAS Approved where stated
- + Kite Marked where stated



### PRESSURE REDUCING VALVES

Pegler pressure reducing valves allow high system pressures to be adjusted to protect downstream equipment and pipelines.

#### FEATURES

- + 1/2" (DN15) to 4" (DN100 size range)
- + Screwed female connection
- + Maximum inlet temperature 80°C
- + Outlet pressure adjustable between 0.5 bar and 6 bar
- + Nickel plated brass finish
- + PN25 rated
- + WRAS Approved



### IN-LINE THERMOSTATIC MIXING VALVES

Pegler in-line mixing valves are designed to eliminate the risk of scalding and are suitable for use in a wide range of public, health care, social, commercial and domestic applications.

#### FEATURES

- + Suitable for sinks, wash basins, bath, bidets, single point showers, hair wash sprays and domestic hot water systems
- + Temperature pre-set to 43°C, but easily adjustable on site
- + Choice of standard, easy to service union connections or 90° angle valve combination
- + Single valve option to meet both TMV3 and TMV2 requirements (BuildCert Approved)
- + Complies with NHS Model Engineering Specification DO8
- + WRAS Approved



# PEGLER VALVES WITH TECTITE PUSH-FIT CONNECTIONS

### BRASS PUSH-FIT BALL VALVES

#### PT500 Brass chrome plated ball valve with lever – full bore

Tectite push-fit ends for copper, carbon and stainless steel tube

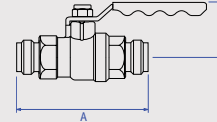

Valve Size	Connection Size	Dimensions in mm		Weight kg	Kv m <sup>3</sup> /h	Code
		A	B			
DN15	15mm	115	39	0.31	17.00	242350
DN15	18mm	115	39	0.31	17.00	242351
DN20	22mm	126	51	0.75	41.00	242352
DN25	28mm	152	55	0.78	70.00	242353
DN32	35mm	194	62	1.46	121.00	242354
DN40	42mm	211	78	2.31	200.00	242355
DN50	54mm	246	84	3.50	292.00	242356

Temperature range: 15mm to 28mm -10°C to +114°C, 35mm to 54mm -10°C to +90°C

#### PT500T Brass chrome plated ball valve with tee – full bore

Tectite push-fit ends for copper, carbon and stainless steel tube

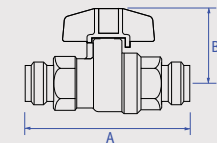

Valve Size	Connection Size	Dimensions in mm		Weight kg	Kv m <sup>3</sup> /h	Code
		A	B			
DN15	15mm	115	39	0.31	17.00	243350
DN15	18mm	115	39	0.31	17.00	243351
DN20	22mm	126	51	0.75	41.00	243352
DN25	28mm	152	55	0.78	70.00	243353

Temperature range: -10°C to +114°C

#### XT500 Brass chrome plated ball valve with lever – full bore

XPress press-fit ends x Tectite push-fit ends for copper, carbon steel and stainless steel tube

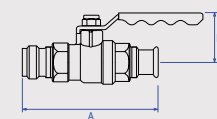

Valve Size	Connection Size	Dimensions in mm		Weight kg	Kv m <sup>3</sup> /h	Code
		A	B			
DN15	15mm	110	39	0.22	17.00	243320
DN15	18mm	110	39	0.22	17.00	243321
DN20	22mm	121	51	0.33	41.00	243322
DN25	28mm	141	55	0.56	70.00	243323
DN32	35mm	184	62	0.99	121.00	243324
DN40	42mm	199	78	1.45	200.00	243325
DN50	54mm	234	84	2.82	292.00	243326

Temperature range: 15mm to 28mm -10°C to +110°C, 35mm to 54mm -10°C to +90°C

Kv = flow rate m<sup>3</sup> per hour at a pressure drop of 1 bar



## DZR PUSH-FIT BALL VALVES

### PT550 DZR ball valve with lever – full bore

Tectite push-fit ends for copper, carbon and stainless steel tube

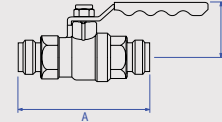

Valve Size	Connection Size	Dimensions in mm		Weight kg	Kv m <sup>3</sup> /h	Code
		A	B			
DN15	15mm	115	39	0.31	17.00	245240
DN15	18mm	115	39	0.75	17.00	245241
DN20	22mm	126	51	0.75	41.00	245242
DN25	28mm	152	55	0.78	70.00	245243
DN32	35mm	194	62	1.46	121.00	245244
DN40	42mm	211	78	2.31	200.00	245245
DN50	54mm	246	84	3.50	292.00	245246

Temperature range: 15mm to 28mm -10°C to +114°C, 35mm to 54mm -10°C to +90°C

### PT550T DZR ball valve with tee – full bore

Tectite push-fit ends for copper, carbon and stainless steel tube

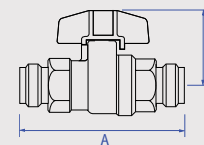

Valve Size	Connection Size	Dimensions in mm		Weight kg	Kv m <sup>3</sup> /h	Code
		A	B			
DN15	15mm	115	39	0.31	17.00	245250
DN15	18mm	115	39	0.31	17.00	245251
DN20	22mm	126	51	0.75	41.00	245252
DN25	28mm	152	55	0.78	70.00	245253

Temperature range: -10°C to +114°C

### XT550 DZR ball valve with lever – full bore

XPress press-fit ends x Tectite push-fit ends for copper, carbon steel and stainless steel tube

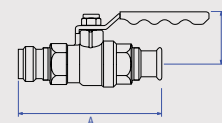

Valve Size	Connection Size	Dimensions in mm		Weight kg	Kv m <sup>3</sup> /h	Code
		A	B			
DN15	15mm	110	39	0.30	17.00	245120
DN15	18mm	110	39	0.30	17.00	245121
DN20	22mm	121	50	0.50	41.00	245122
DN25	28mm	141	55	0.76	70.00	245123
DN32	35mm	184	62	1.33	121.00	245124
DN40	42mm	199	78	1.84	200.00	245125
DN50	54mm	234	84	2.82	292.00	245126

Temperature range: 15mm to 28mm -10°C to +110°C, 35mm to 54mm -10°C to +90°C



# PEGLER VALVES WITH TECTITE PUSH-FIT CONNECTIONS

### DZR BRASS PUSH-FIT BALL VALVES

#### XT550EL DZR ball valve with extended lever – full bore

XPress press-fit ends x Tectite push-fit ends for copper, carbon steel and stainless steel tube

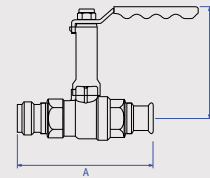

Valve Size	Connection Size	Dimensions in mm		Weight kg	Kv m <sup>3</sup> /h	Code
		A	B			
DN15	15mm	110	83	0.37	17.00	245273
DN15	18mm	110	83	0.38	17.00	245274
DN20	22mm	121	97	0.61	41.00	245275
DN25	28mm	141	101	0.86	70.00	245276
DN32	35mm	184	108	1.42	121.00	245277
DN40	42mm	199	128	2.00	200.00	245278
DN50	54mm	234	146.2	3.08	292.00	245279

Temperature range: 15mm to 28mm -10°C to +110°C, 35mm to 54mm -10°C to +90°C

### BRASS PUSH-FIT QUARTER TURN BALL VALVES

#### TX300 DZR Brass quarter turn ball valve – full bore

Tectite ends for copper, carbon and stainless steel

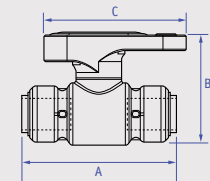

Valve Size	Connection Size	Dimensions in mm			Weight kg	Kv m <sup>3</sup> /h	Code
		A	B	C			
DN15	15mm	71	38	65	0.19	17.00	66001
DN15	22mm	88	47	78	0.34	41.00	66004

Temperature range: -10°C to +95°C

#### Securing clip for TX300

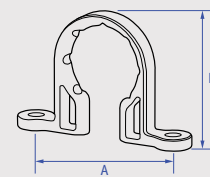

Connection Size	Dimensions in mm		Weight kg	Code
	A	B		
15mm	50	34	0.003	66006
22mm	64	43	0.004	66007

### BALLOFIX DZR PUSH-FIT ISOLATING BALL VALVES

#### Ballofix Isolating ball valve – straight pattern

Tectite push-fit ends for copper, chrome finish

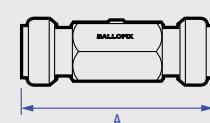

Valve Size	Connection Size	Pattern No.	Dimensions in mm A	Weight kg	Code
DN15	15mm	6381ZA	85	0.14	13073

Kv = flow rate m<sup>3</sup> per hour at a pressure drop of 1 bar



### Ballofix Isolating ball valve – straight pattern

Tectite push-fit ends for copper, chrome finish, plastic lever operation

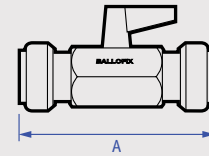

Valve Size	Connection Size	Pattern No.	Dimensions in mm A	Weight kg	Code
DN15	15mm	6381ZP	85	0.15	13081
DN20	22mm	6481ZP	100	0.21	13082

### Ballofix Isolating ball valve – straight pattern

Tectite push-fit end for copper male end, screwdriver slot, DZR, chrome finish

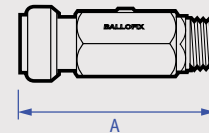

Valve Size	Connection Size	Pattern No.	Dimensions in mm A	Weight kg	Code
DN15	15mm x 1/2"	7310ZA	62.1	0.12	13263

### Ballofix Isolating ball valve – straight pattern

Tectite push-fit end for copper female end, screwdriver slot, DZR, chrome finish

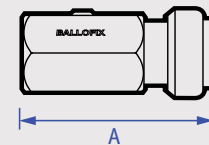

Valve Size	Connection Size	Pattern No.	Dimensions in mm A	Weight kg	Code
DN15	15mm x 1/2"	7331ZA	62.1	0.13	13264

## BRONZE PUSH-FIT GATE VALVES

### PT1070/125 Bronze full way gate valve

Tectite push-fit ends for copper, carbon and stainless steel tube

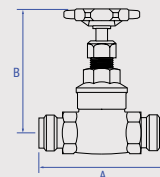

Valve Size	Connection Size	Dimensions in mm		Weight kg	Kv m <sup>3</sup> /h	Code
		A	B			
DN15	15mm	101	85	0.39	14.00	103400
DN15	18mm	105	85	0.40	32.00	103401
DN20	22mm	124	95	0.57	57.00	103402
DN25	28mm	140	110	0.87	90.00	103403
DN32	35mm	175	125	1.54	129.00	103404
DN40	42mm	187	145	2.14	230.00	103405
DN50	54mm	214	170	3.17	428.00	103406

Temperature range: 15mm to 28mm -10°C to +114°C, 35mm to 54mm -10°C to +90°C. WRAS approval temperature 85°C.

Kv = flow rate m<sup>3</sup> per hour at a pressure drop of 1 bar

# PEGLER VALVES WITH TECTITE PUSH-FIT CONNECTIONS

### PT1070/125LS Bronze full way gate valve with lockshield

Tectite push-fit ends for copper, carbon and stainless steel tube

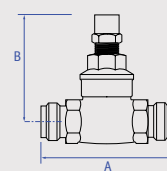

Valve Size	Connection Size	Dimensions in mm		Weight kg	Kv m <sup>3</sup> /h	Code
		A	B			
DN15	15mm	101	75	0.39	14.00	103410
DN15	18mm	105	75	0.40	32.00	103411
DN20	22mm	124	85	0.57	57.00	103412
DN25	28mm	140	100	0.87	90.00	103413
DN32	35mm	175	110	1.54	129.00	103414
DN40	42mm	187	130	2.14	230.00	103415
DN50	54mm	214	155	3.17	428.00	103416

Temperature range: 15mm to 28mm -10°C to +114°C, 35mm to 54mm -10°C to +90°C. WRAS approval temperature 85°C.

### BRASS PUSH-FIT GATE VALVES

### PT1068 Brass full way gate valve

Tectite push-fit ends for copper, carbon and stainless steel tube

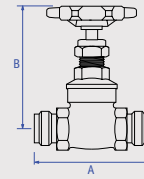

Valve Size	Connection Size	Dimensions in mm		Weight kg	Kv m <sup>3</sup> /h	Code
		A	B			
DN15	15mm	101	85	0.38	14.00	203400
DN15	18mm	105	85	0.39	32.00	203401
DN20	22mm	124	95	0.57	57.00	203402
DN25	28mm	140	110	0.90	90.00	203403
DN32	35mm	175	125	1.58	129.00	203404
DN40	42mm	187	145	2.07	230.00	203405
DN50	54mm	214	170	3.34	428.00	203406

Temperature range: 15mm to 28mm -10°C to +114°C, 35mm to 54mm -10°C to +90°C. WRAS approval temperature 85°C.

### PT1068LS Brass full way gate valve with lockshield

Tectite push-fit ends for copper, carbon and stainless steel tube

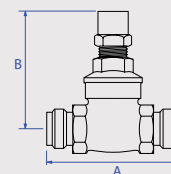

Valve Size	Connection Size	Dimensions in mm		Weight kg	Kv m <sup>3</sup> /h	Code
		A	B			
DN15	15mm	101	75	0.38	14.00	203410
DN15	18mm	105	75	0.39	32.00	203411
DN20	22mm	124	85	0.57	57.00	203412
DN25	28mm	140	100	0.90	90.00	203413
DN32	35mm	175	110	1.58	129.00	203414
DN40	42mm	187	130	2.07	230.00	203415
DN50	54mm	214	155	3.34	428.00	203416

Temperature range: 15mm to 28mm -10°C to +114°C, 35mm to 54mm -10°C to +90°C. WRAS approval temperature 85°C.

Kv = flow rate m<sup>3</sup> per hour at a pressure drop of 1 bar





## XT1068 Brass full way gate valve

XPress press-fit ends x Tectite push-fit ends for copper, carbon steel and stainless steel tube

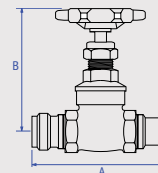

Valve Size	Connection Size	Dimensions in mm		Weight kg	Kv m <sup>3</sup> /h	Code
		A	B			
DN15	15mm	99	85	0.39	14.00	203320
DN15	18mm	100	85	0.39	14.00	203321
DN20	22mm	109	95	0.56	32.00	203322
DN25	28mm	124	110	0.85	57.00	203323
DN32	35mm	162	125	1.41	90.00	203324
DN40	42mm	175	145	1.90	129.00	203325
DN50	54mm	200	170	2.92	230.00	203326

Temperature range: 15mm to 28mm -10°C to +110°C, 35mm to 54mm -10°C to +90°C. WRAS approval temperature 85°C.

## XT1068LS Brass full way gate valve with lockshield

XPress press-fit ends x Tectite push-fit ends for copper/ carbon steel/stainless steel tube

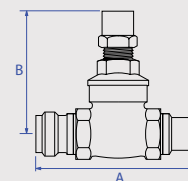

Valve Size	Connection Size	Dimensions in mm		Weight kg	Kv m <sup>3</sup> /h	Code
		A	B			
DN15	15mm	99	75	0.39	14.00	203327
DN15	18mm	100	75	0.39	14.00	203328
DN20	22mm	109	85	0.56	32.00	203329
DN25	28mm	124	100	0.85	57.00	203330
DN32	35mm	162	110	1.41	90.00	203331
DN40	42mm	175	130	1.90	129.00	203332
DN50	54mm	200	155	2.92	230.00	203333

Temperature range: 15mm to 28mm -10°C to +110°C, 35mm to 54mm -10°C to +90°C. WRAS approval temperature 85°C.

## BRONZE PUSH-FIT SWING CHECK VALVES

### PT1060A Swing check valve

Tectite push-fit ends for copper, carbon and stainless steel tube

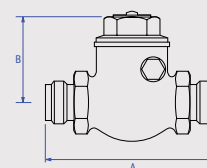

Valve Size	Connection Size	Dimensions in mm		Weight kg	Flow l/s	Kv m <sup>3</sup> /h	Code
		A	B				
DN15	15mm	111	45	0.45	0.04	1.80	122350
					0.10	3.70	
					0.20	5.10	
					0.40	5.70	
DN15	18mm	125	55	0.69	0.04	2.70	122351
					0.10	5.50	
					0.40	13.60	
DN20	22mm	135	55	0.69	1.00	15.30	122352
					0.04	2.70	
					0.10	5.50	
					0.40	13.60	
					1.00	15.30	

Kv = flow rate m<sup>3</sup> per hour at a pressure drop of 1 bar

# PEGLER VALVES WITH TECTITE PUSH-FIT CONNECTIONS

### PT1060A Swing check valve

Tectite push-fit ends for copper, carbon and stainless steel tube

DN	Connection Size	Weight (kg)	Length (mm)	Height (mm)	Flow Coefficient (Kv)	Pressure Drop (bar)	Code
DN25	28mm	150	60	1.04	0.01	7.70	122353
					0.20	13.90	
					0.30	18.40	
					1.00	25.30	
DN32	35mm	144	65	1.77	0.20	15.00	122354
					0.30	20.60	
					0.40	25.30	
					1.00	32.60	
DN50	42mm	216	75	2.40	0.40	30.30	122355
					0.60	40.20	
					0.80	48.50	
					3.00	54.40	
DN50	54mm	249	90	3.55	0.60	42.00	122356
					0.80	54.00	
					1.50	86.20	
					4.00	98.00	

Temperature range: 15mm to 28mm -10°C to +114°C, 35mm to 54mm -10°C to +90°C

### BRONZE PUSH-FIT STRAINERS

### PT913 Bronze Y pattern strainer

Tectite push-fit ends for copper, carbon and stainless steel tube

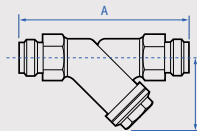

Valve Size	Connection Size	Dimensions in mm		Weight kg	Code
		A	B		
DN15	15mm	107	44	0.30	15480
DN15	18mm	118	47	0.31	15481
DN20	22mm	128	47	0.43	15482
DN25	28mm	149	58	0.62	15483
DN32	35mm	197	68	1.25	15484
DN40	42mm	220	78	1.90	15485
DN50	54mm	255	98	2.49	15486

Temperature range: 15mm to 28mm -10°C to +114°C, 35mm to 54mm -10°C to +90°C

### BRASS PUSH-FIT PRESSURE REDUCING VALVE

### PT5 PRV DZR Brass pressure reducing valve

Tectite x Tectite push-fit ends for copper, carbon steel and stainless steel tube. Adjustable outlet pressure 1-6bar

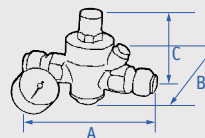

Valve Size	Connection Size	Dimensions in mm			Weight kg	Code
		A	B	C		
DN15	15mm	133	93	62	0.76	5A2050

Temperature range -10°C to +80°C

Kv = flow rate m<sup>3</sup> per hour at a pressure drop of 1 bar



## PRESSURE GAUGE

### PG Pressure Gauge

Suitable for PRV 4 pressure reducing valves. 0-10bar

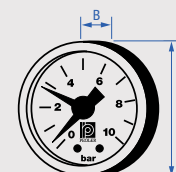

Valve Size	Connection Size	Dimensions in mm		Weight kg	Code
		A	B		
1/4"	1/4"	40.3	40.5	0.096	5A2003

### TX402 In-line thermostatic mixing valve

Tectite push-fit ends for copper and stainless steel tube.  
Anti-scald valve

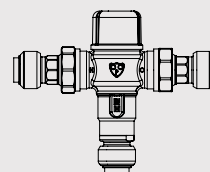

Valve Size	Dimensions in mm		Code
	A	B	
15mm	114	144	5A1560
22mm	112	165	5A1561

### TX402UA In-line thermostatic mixing valve

Tectite push-fit ends for copper and stainless steel tube.  
Anti-scald valve

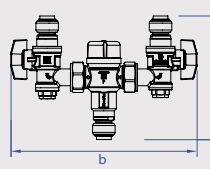

Valve Size	Dimensions in mm		Code
	A	B	
15mm	143	211	5A1562
22mm	152	248	5A1563

### TX402UAX In-line thermostatic mixing valve

Tectite push-fit ends for copper and stainless steel tube.  
Anti-scald valve

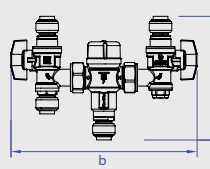

Valve Size	Dimensions in mm		Code
	A	B	
15mm	143	211	5A1564
22mm	152	248	5A1565

Kv = flow rate m<sup>3</sup> per hour at a pressure drop of 1 bar



# PEGLER VALVES WITH XPRESS PRESS-FIT CONNECTIONS

### CHROME PLATED BRASS PRESS-FIT BALL VALVES

#### PS500 Brass chrome plated ball valve with lever – full bore

XPress press-fit ends for copper, carbon steel and stainless steel tube

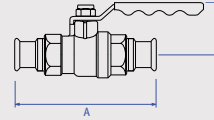

Valve Size	Connection Size	Dimensions in mm		Weight kg	Kv m <sup>3</sup> /h	Code
		A	B			
DN15	15mm	105	39	0.30	17.00	242301
DN15	18mm	105	39	0.31	17.00	242302
DN20	22mm	115	50	0.50	41.00	242303
DN25	28mm	131	55	0.75	70.00	242304
DN32	35mm	152	62	1.17	121.00	242305
DN40	42mm	165	78	1.85	200.00	242306
DN50	54mm	197	84	3.00	292.00	242307

Temperature range: -10°C to +110°C

#### PS500T Brass chrome plated ball valve with tee – full bore

XPress press-fit ends for copper, carbon steel and stainless steel tube

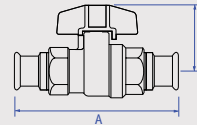

Valve Size	Connection Size	Dimensions in mm		Weight kg	Kv m <sup>3</sup> /h	Code
		A	B			
DN15	15mm	105	40	0.30	17.00	243301
DN15	18mm	105	40	0.31	17.00	243302
DN20	22mm	115	51	0.50	41.00	243303
DN25	28mm	131	55	0.75	70.00	243304

Temperature range: -10°C to +110°C

#### PSU500 Brass chrome plated ball valve with lever – full bore

XPress union x XPress press-fit ends for copper, carbon steel and stainless steel tube

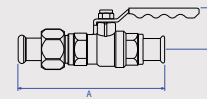

Valve Size	Connection Size	Dimensions in mm		Weight kg	Kv m <sup>3</sup> /h	Code
		A	B			
DN15	15mm	128	39	0.390	17.00	243330
DN15	18mm	128	39	0.394	17.00	243331
DN20	22mm	147	50	0.627	41.00	243332
DN25	28mm	160	55	0.958	70.00	243333
DN32	35mm	178	70	1.410	121.00	243334
DN40	42mm	195	78	1.910	200.00	243335
DN50	54mm	233	84	3.000	292.00	243336

Temperature range: -10°C to +110°C

Kv = flow rate m<sup>3</sup> per hour at a pressure drop of 1 bar



## PSU500EL

### Brass chrome plated ball valve with extended lever – full bore

XPress union x XPress press-fit ends for copper, carbon steel and stainless steel tube

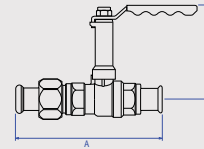

Valve Size	Connection Size	Dimensions in mm		Weight kg	Kv m <sup>3</sup> /h	Code
		A	B			
DN15	15mm	128	83	0.460	17.00	243340
DN15	18mm	128	83	0.470	17.00	242341
DN20	22mm	147	97	0.740	41.00	243342
DN25	28mm	160	110	1.050	70.00	243343
DN32	35mm	178	108	1.500	121.00	243344
DN40	42mm	195	128	2.080	200.00	243345
DN50	54mm	233	146	3.340	292.00	243346

Temperature range: -10°C to +110°C

## DZR BRASS PRESS-FIT BALL VALVES

### PS550

### DZR ball valve with lever – full bore

XPress press-fit ends for copper, carbon steel and stainless steel tube

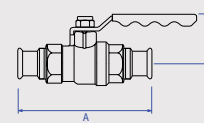

Valve Size	Connection Size	Dimensions in mm		Weight kg	Kv m <sup>3</sup> /h	Code
		A	B			
DN15	15mm	105	39	0.30	17.00	245220
DN15	18mm	105	39	0.31	17.00	245221
DN20	22mm	115	50	0.50	41.00	245222
DN25	28mm	131	55	0.75	70.00	245223
DN32	35mm	152	62	1.17	121.00	245224
DN40	42mm	165	78	1.85	200.00	245225
DN50	54mm	197	84	3.00	292.00	245226

Temperature range: -10°C to +110°C

### PS550T

### DZR ball valve with tee – full bore

XPress press-fit ends for copper, carbon steel and stainless steel tube

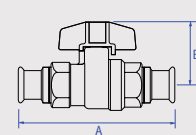

Valve Size	Connection Size	Dimensions in mm		Weight kg	Kv m <sup>3</sup> /h	Code
		A	B			
DN15	15mm	105	40	0.30	17.00	245230
DN15	18mm	105	40	0.31	17.00	245231
DN20	22mm	115	51	0.50	41.00	245232
DN25	28mm	131	55	0.75	70.00	245233

Temperature range: -10°C to +110°C

Kv = flow rate m<sup>3</sup> per hour at a pressure drop of 1 bar

# PEGLER VALVES WITH XPRESS PRESS-FIT CONNECTIONS

### PS550EL DZR ball valve with extended lever – full bore

XPress press-fit ends x Tectite push-fit ends for copper, carbon steel and stainless steel tube

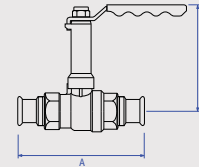

Valve Size	Connection Size	Dimensions in mm		Weight kg	Kv m <sup>3</sup> /h	Code
		A	B			
DN15	15mm	105	83	0.372	17.00	245300
DN15	18mm	105	83	0.374	17.00	245301
DN20	22mm	115	97	0.598	41.00	245302
DN25	28mm	131	101	0.72	70.00	245303
DN32	35mm	152	108	1.25	121.00	245304
DN40	42mm	165	128	1.77	200.00	245305
DN50	54mm	197	146.2	2.81	292.00	245306

Temperature range: -10°C to +110°C

### PSU550 DZR ball valve with lever – full bore

XPress union x XPress press-fit ends for copper, carbon steel and stainless steel tube

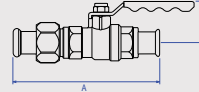

Valve Size	Connection Size	Dimensions in mm		Weight kg	Kv m <sup>3</sup> /h	Code
		A	B			
DN15	15mm	128	39	0.390	17.00	245310
DN15	18mm	128	39	0.394	17.00	245311
DN20	22mm	147	50	0.627	41.00	245312
DN25	28mm	160	55	0.958	70.00	245313
DN32	35mm	178	70	1.410	121.00	245314
DN40	42mm	195	78	1.910	200.00	245315
DN50	54mm	233	84	3.000	292.00	245316

Temperature range: -10°C to +110°C

### PSU550EL DZR ball valve with extended lever – full bore

XPress union x XPress press-fit ends for copper, carbon steel and stainless steel tube

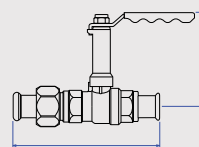

Valve Size	Connection Size	Dimensions in mm		Weight kg	Kv m <sup>3</sup> /h	Code
		A	B			
DN15	15mm	128	83	0.460	17.00	245320
DN15	18mm	128	83	0.470	17.00	245321
DN20	22mm	147	97	0.740	41.00	245322
DN25	28mm	160	110	1.050	70.00	245323
DN32	35mm	178	108	1.500	121.00	245324
DN40	42mm	195	128	2.080	200.00	245325
DN50	54mm	233	146	3.340	292.00	245326

Temperature range: -10°C to +110°C

Kv = flow rate m<sup>3</sup> per hour at a pressure drop of 1 bar





## BALLOFIX DZR PRESS-FIT ISOLATING BALL VALVES

### Ballofix Isolating ball valve – straight pattern

XPress ends for copper/carbon steel/stainless steel tube.  
Screwdriver slot

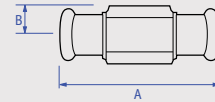

Valve Size	Connection Size	Pattern No.	Dimensions in mm	Weight kg	Code
			A		
DN15	15mm	4381ZA	83	0.16	13060
DN20	22mm	4481ZA	88	0.20	13061

## BALLOFIX DZR PRESS-FIT ISOLATING BALL VALVES

### Ballofix Isolating ball valve – straight pattern

XPress x male iron for copper/carbon steel/stainless steel tube. Chrome plated, screwdriver slot

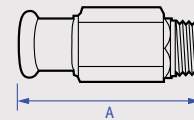

Valve Size	Connection Size	Pattern No.	Dimensions in mm	Weight kg	Code
			A		
DN15	15mm x 1/2"	8310ZA	59.2	0.12	13260
DN20	22mm x 3/4"	8510ZA	62.9	0.17	13262

## BRONZE PRESS-FIT GATE VALVES

### PS1070/125 Bronze full way gate valve

XPress press-fit ends for copper, carbon steel and stainless steel tube

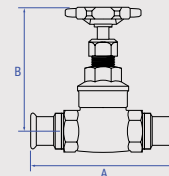

Valve Size	Connection Size	Dimensions in mm		Weight kg	Kv m <sup>3</sup> /h	Code
		A	B			
DN15	15mm	98	85	0.39	14.00	103301
DN15	18mm	98	85	0.39	14.00	103302
DN20	22mm	104	95	0.56	32.00	103303
DN25	28mm	117	110	0.84	57.00	103304
DN32	35mm	130	125	1.26	90.00	103305
DN40	42mm	141	145	1.69	129.00	103306
DN50	54mm	165	170	2.67	230.00	103307

Temperature range: -10°C to +110°C. WRAS approval temperature 85°C.

Kv = flow rate m<sup>3</sup> per hour at a pressure drop of 1 bar

# PEGLER VALVES WITH XPRESS PRESS-FIT CONNECTIONS

### PS1070/125LS Bronze full way gate valve with lockshield

XPress press-fit ends for copper, carbon steel and stainless steel tube

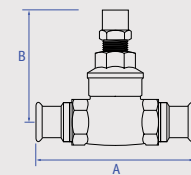

Valve Size	Connection Size	Dimensions in mm		Weight kg	Kv m <sup>3</sup> /h	Code
		A	B			
DN15	15mm	98	75	0.39	14.00	103311
DN15	18mm	98	75	0.39	14.00	103312
DN20	22mm	104	85	0.56	32.00	103313
DN25	28mm	117	100	0.84	57.00	103314
DN32	35mm	130	110	1.26	90.00	103315
DN40	42mm	141	130	1.69	129.00	103316
DN50	54mm	165	155	2.67	230.00	103317

Temperature range: -10°C to +110°C. WRAS approval temperature 85°C.

### PSU1070/125 Bronze full way gate valve

XPress union x XPress press-fit ends for copper, carbon steel and stainless steel tube

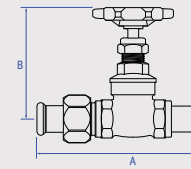

Valve Size	Connection Size	Dimensions in mm		Weight kg	Kv m <sup>3</sup> /h	Code
		A	B			
DN15	15mm	121	85	0.481	14.00	103320
DN15	18mm	121	85	0.484	14.00	103321
DN20	22mm	135	95	0.690	32.00	103322
DN25	28mm	146	110	1.040	57.00	103323
DN32	35mm	156	125	1.490	90.00	103324
DN40	42mm	171	145	1.980	129.00	103325
DN50	54mm	199	170	3.180	230.00	103326

Temperature range: -10°C to +110°C. WRAS approval temperature 85°C.

### PSU1070/125LS Bronze full way gate valve with lockshield

XPress union x XPress press-fit ends for copper, carbon steel and stainless steel tube

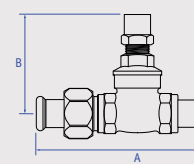

Valve Size	Connection Size	Dimensions in mm		Weight kg	Kv m <sup>3</sup> /h	Code
		A	B			
DN15	15mm	121	75	0.481	14.00	103330
DN15	18mm	121	75	0.484	14.00	103331
DN20	22mm	135	85	0.690	32.00	103332
DN25	28mm	146	100	1.040	57.00	103333
DN32	35mm	156	110	1.490	90.00	103334
DN40	42mm	171	130	1.980	129.00	103335
DN50	54mm	199	155	3.180	230.00	103336

Temperature range: -10°C to +110°C. WRAS approval temperature 85°C.

Kv = flow rate m<sup>3</sup> per hour at a pressure drop of 1 bar



## BRASS PRESS-FIT GATE VALVES

### PS1068

#### Brass full way gate valve

XPress press-fit ends for copper, carbon steel and stainless steel tube

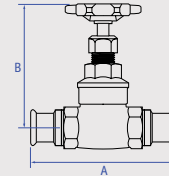

Valve Size	Connection Size	Dimensions in mm		Weight kg	Kv m <sup>3</sup> /h	Code
		A	B			
DN15	15mm	98	85	0.38	14.00	203301
DN15	18mm	98	85	0.38	14.00	203302
DN20	22mm	104	95	0.56	32.00	203303
DN25	28mm	117	110	0.87	57.00	203304
DN32	35mm	130	125	1.30	90.00	203305
DN40	42mm	141	145	1.62	129.00	203306
DN50	54mm	165	170	2.84	230.00	203307

Temperature range: -10°C to +110°C. WRAS approval temperature 85°C.

### PS1068LS

#### Brass full way gate valve with lockshield

XPress press-fit ends for copper, carbon steel and stainless steel tube

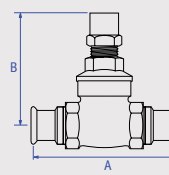

Valve Size	Connection Size	Dimensions in mm		Weight kg	Kv m <sup>3</sup> /h	Code
		A	B			
DN15	15mm	98	75	0.38	14.00	203311
DN15	18mm	98	75	0.38	14.00	203312
DN20	22mm	104	85	0.56	32.00	203313
DN25	28mm	117	100	0.87	57.00	203314
DN32	35mm	130	110	1.30	90.00	203315
DN40	42mm	141	130	1.62	129.00	203316
DN50	54mm	165	155	2.84	230.00	203317

Temperature range: -10°C to +110°C. WRAS approval temperature 85°C.

### PSU1068

#### Brass full way gate valve

XPress union x XPress press-fit ends for copper, carbon steel and stainless steel tube

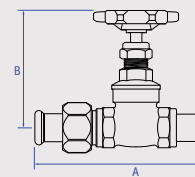

Valve Size	Connection Size	Dimensions in mm		Weight kg	Kv m <sup>3</sup> /h	Code
		A	B			
DN15	15mm	121	85	0.481	14.00	203340
DN15	18mm	121	85	0.484	14.00	203341
DN20	22mm	135	95	0.690	32.00	203342
DN25	28mm	146	110	1.040	57.00	203343
DN32	35mm	156	125	1.490	90.00	204344
DN40	42mm	171	145	1.980	129.00	203345
DN50	54mm	199	170	3.180	230.00	203346

Temperature range: -10°C to +110°C. WRAS approval temperature 85°C.

Kv = flow rate m<sup>3</sup> per hour at a pressure drop of 1 bar

# PEGLER VALVES WITH XPRESS PRESS-FIT CONNECTIONS

### PSU1068LS

#### Brass full way gate valve with lockshield

XPress union x XPress press-fit ends for copper, carbon steel and stainless steel tube

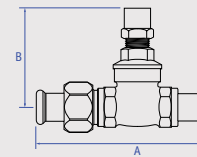

Valve Size	Connection Size	Dimensions in mm		Weight kg	Kv m <sup>3</sup> /h	Code
		A	B			
DN15	15mm	121	75	0.481	14.00	203350
DN15	18mm	121	75	0.484	14.00	203351
DN20	22mm	135	85	0.690	32.00	203352
DN25	28mm	146	100	1.040	57.00	203353
DN32	35mm	156	110	1.490	90.00	203354
DN40	42mm	171	130	1.980	129.00	203355
DN50	54mm	199	155	3.180	230.00	203356

Temperature range: -10°C to +110°C. WRAS approval temperature 85°C.

### BRONZE PRESS-FIT GATE VALVES

### PS1078

#### DZR full way gate valve

XPress press-fit ends for copper, carbon steel and stainless steel tube

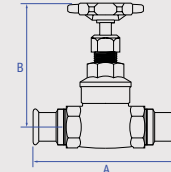

Valve Size	Connection Size	Dimensions in mm		Weight kg	Kv m <sup>3</sup> /h	Code
		A	B			
DN15	15mm	98	85	0.38	14.00	204056
DN15	18mm	98	85	0.38	14.00	204057
DN20	22mm	104	95	0.56	32.00	204058
DN25	28mm	117	110	0.87	57.00	204059
DN32	35mm	130	125	1.30	90.00	204060
DN40	42mm	141	145	1.62	129.00	204061
DN50	54mm	165	170	2.84	230.00	204062

Temperature range: -10°C to +110°C. WRAS approval temperature 85°C.

### PS1078LS

#### DZR full way gate valve with lockshield

XPress press-fit ends for copper, carbon steel and stainless steel tube

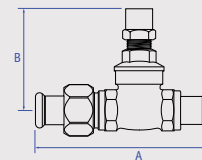

Valve Size	Connection Size	Dimensions in mm		Weight kg	Kv m <sup>3</sup> /h	Code
		A	B			
DN15	15mm	98	75	0.38	14.00	204063
DN15	18mm	104	75	0.38	14.00	204064
DN20	22mm	104	85	0.56	32.00	204065
DN25	28mm	117	100	0.87	57.00	204066
DN30	35mm	130	110	1.30	90.00	204067
DN40	42mm	141	130	1.62	129.00	204068
DN50	54mm	165	155	2.84	230.00	204069

Temperature range: -10°C to +110°C. WRAS approval temperature 85°C.

Kv = flow rate m<sup>3</sup> per hour at a pressure drop of 1 bar





## PSU1078 DZR full way gate valve

XPress union x XPress press-fit end for copper, carbon steel and stainless steel tube

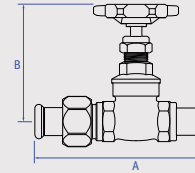

Valve Size	Connection Size	Dimensions in mm		Weight kg	Kv m <sup>3</sup> /h	Code
		A	B			
DN15	15mm	121	85	0.481	14.00	204080
DN15	18mm	121	85	0.484	14.00	204081
DN20	22mm	135	95	0.690	32.00	204082
DN25	28mm	146	110	1.040	57.00	204083
DN32	35mm	156	125	1.490	90.00	204084
DN40	42mm	171	145	1.980	129.00	204085
DN50	54mm	199	170	3.180	230.00	204086

Temperature range: -10°C to +110°C. WRAS approval temperature 85°C.

## PSU1078LS DZR full way gate valve with lockshield

XPress union x XPress press-fit ends for copper, carbon steel and stainless steel tube

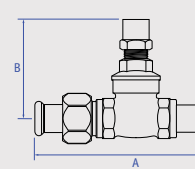

Valve Size	Connection Size	Dimensions in mm		Weight kg	Kv m <sup>3</sup> /h	Code
		A	B			
DN15	15mm	121	75	0.481	14.00	204090
DN15	18mm	121	75	0.484	14.00	204091
DN20	22mm	135	85	0.690	32.00	204092
DN25	28mm	146	100	1.040	57.00	204093
DN32	35mm	156	110	1.490	90.00	204094
DN40	42mm	171	130	1.980	129.00	204095
DN50	54mm	199	155	3.180	230.00	204096

Temperature range: -10°C to +110°C. WRAS approval temperature 85°C.

## BRONZE PRESS-FIT CHECK VALVES

### PS1060A Press-fit swing check valve

XPress press-fit ends for copper, carbon steel and stainless steel tube

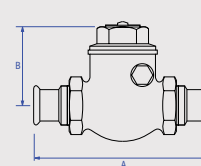

Valve Size	Connection Size	Dimensions in mm		Weight kg	Flow l/s	Kv m <sup>3</sup> /h	Code
		A	B				
DN15	15mm	108	45	0.45	0.04	1.80	122301
					0.10	3.70	
					0.20	5.10	
					0.40	5.70	
DN15	18mm	108	45	0.45	0.04	1.80	122302
					0.10	3.70	
					0.20	5.10	
					0.40	5.70	
DN20	22mm	124	55	0.68	0.04	2.70	122303
					0.10	5.50	
					0.40	13.60	
					1.00	15.30	

Kv = flow rate m<sup>3</sup> per hour at a pressure drop of 1 bar

# PEGLER VALVES WITH XPRESS PRESS-FIT CONNECTIONS

### PS1060A - Continued

Valve Size	Connection Size	Weight (kg)	Dimension A (mm)	Dimension B (mm)	Flow (l/s)	Flow (m³/h)	Code
DN25	28mm	1.01	135	60	0.01	7.70	122304
DN32	35mm	1.49	151	65	0.20	15.00	122305
					0.30	26.60	
					0.40	25.30	
					1.00	32.60	
DN40	42mm	1.95	170	75	0.40	30.30	122306
					0.60	40.20	
					0.80	48.50	
					3.00	54.40	
DN50	54mm	3.05	200	90	0.60	42.00	122307
					0.80	54.00	
					1.50	86.20	
					4.00	98.00	

Temperature range: -10°C to +110°C

### PSU1060A Bronze swing check valve

XPress union outlet x XPress press-fit ends for copper, carbon steel and stainless steel tube

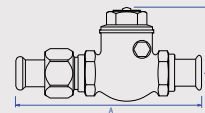

Valve Size	Connection Size	Dimensions in mm		Weight kg	Flow l/s	Kv m³/h	Code
		A	B				
DN15	15mm	131	45	0.557	0.04	1.80	122310
					0.10	3.70	
					0.20	5.10	
					0.40	5.70	
DN15	18mm	131	45	0.560	0.04	1.80	122311
					0.10	3.70	
					0.20	5.10	
					0.40	5.70	
DN20	22mm	155	55	0.837	0.04	2.70	122312
					0.10	5.50	
					0.40	13.60	
					1.00	15.30	
DN25	28mm	164	60	1.214	0.01	7.70	122313
					0.20	13.90	
					0.30	18.40	
					1.00	25.30	
DN32	35mm	177	65	1.739	0.20	15.00	122314
					0.30	26.60	
					0.40	25.30	
					1.00	32.60	
DN40	42mm	200	75	2.169	0.40	30.30	122315
					0.60	40.20	
					0.80	48.50	
					3.00	54.40	
DN50	54mm	234	90	3.503	0.60	42.00	122316
					0.80	54.00	
					1.50	86.20	
					4.00	98.00	

Temperature range: -10°C to +110°C

Kv = flow rate m³ per hour at a pressure drop of 1 bar



## DZR PRESS-FIT DOUBLE CHECK VALVES

### PS4426 DZR double check valve to EN 13959:2004 Type E D

XPress x XPress press-fit ends for copper, carbon steel and stainless steel tube

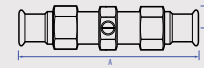

Valve Size	Connection Size	Dimensions in mm		Weight kg	Code
		A	B		
DN15	15mm	116	15	0.220	42050
DN20	22mm	130	18	0.330	42051
DN25	28mm	158	22	0.520	42052
DN32	35mm	159	27	0.820	42053
DN40	42mm	200	30	1.340	42054
DN50	54mm	274	38	2.440	42055

Temperature range: -10°C to +65°C

### PSU4426 DZR double check valve to EN 13959:2004 Type E D

XPress union outlet x XPress press-fit ends for copper, carbon steel and stainless steel tube

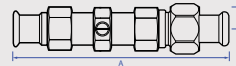

Valve Size	Connection Size	Dimensions in mm		Weight kg	Code
		A	B		
DN15	15mm	140	15	0.315	42082
DN15	18mm	140	15	0.319	42083
DN20	22mm	161	18	0.467	42084
DN25	28mm	187	22	0.769	42085
DN32	35mm	205	27	1.068	42086
DN40	42mm	230	30	1.568	42087
DN50	54mm	308	38	4.125	42088

Temperature range: -10°C to +65°C

## BRONZE PRESS-FIT Y PATTERN STRAINERS

### PS913 Bronze Y pattern strainer

XPress press-fit ends for copper, carbon steel and stainless steel tube

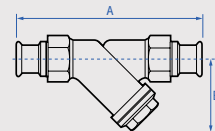

Valve Size	Connection Size	Dimensions in mm		Weight kg	Code
		A	B		
DN15	15mm	109	40	0.30	15472
DN15	18mm	109	40	0.30	15473
DN20	22mm	115	48	0.41	15474
DN25	28mm	132	60	0.59	15475
DN32	35mm	171	70	0.96	15476
DN40	42mm	185	82	1.19	15477
DN50	54mm	212	73	2.00	15478

Temperature range: -10°C to +110°C

Kv = flow rate m<sup>3</sup> per hour at a pressure drop of 1 bar

# PEGLER VALVES WITH XPRESS PRESS-FIT CONNECTIONS

### PSU913 Bronze Y strainer

XPress union outlet x XPress press-fit ends for copper, carbon steel and stainless steel tube

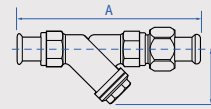

Valve Size	Connection Size	Dimensions in mm		Weight kg	Code
		A	B		
DN15	15mm	132	40	0.361	15437
DN15	18mm	132	40	0.364	15438
DN20	22mm	146	48	0.517	15439
DN25	28mm	161	60	0.854	15440
DN32	35mm	197	70	1.179	15441
DN40	42mm	215	82	1.566	15442
DN50	54mm	246	73	2.482	15443

Temperature range: -10°C to +110°C

### BRASS PRESS-FIT PRESSURE REDUCING VALVES

### PS4 PRV Brass nickel plated pressure reducing valve

XPress x XPress press-fit ends for copper, carbon steel and stainless steel tube. Adjustable outlet pressure 0.5-6bar

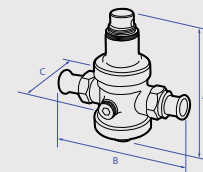

Valve Size	Connection Size	Dimensions in mm			Weight kg	Code
		A	B	C		
DN15	15mm	118	123	66	0.78	5A2070
DN15	18mm	118	123	66	0.78	5A2071
DN20	22mm	141	139	73	1.22	5A2072
DN25	28mm	152	143	75	1.48	5A2073
DN32	35mm	217	173	94	2.51	5A2074
DN40	42mm	218	190	95	2.70	5A2075
DN50	54mm	244	217	114	4.00	5A2076

Temperature range -10°C to +80°C

### PSU4 PRV Brass nickel plated pressure reducing valve

XPress union outlet x XPress press-fit ends for copper, carbon steel and stainless steel tube. Adjustable outlet pressure 0.5-6bar

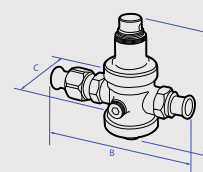

Valve Size	Connection Size	Dimensions in mm			Weight kg	Code
		A	B	C		
DN15	15mm	118	146	66	0.89	5A2060
DN15	18mm	118	146	66	0.89	5A2061
DN20	22mm	141	170	73	1.35	5A2062
DN25	28mm	152	172	75	3.04	5A2063
DN32	35mm	217	199	94	3.68	5A2064
DN40	42mm	218	220	95	3.98	5A2065
DN50	54mm	244	251	114	4.50	5A2066

Temperature range -10°C to +80°C

Kv = flow rate m<sup>3</sup> per hour at a pressure drop of 1 bar



# PEGLER VALVES WITH HENCO MULTI-LAYER CONNECTIONS



## HENCO MULTI-LAYER PRESS-FIT BALL VALVES - PVDF RANGE

### MLH500

#### Chrome plated brass quarter turn lever ball valve

Flat face union connections for multi-layer tube



Valve Size	Connection Size	Dimensions in mm		Weight kg	Kv m <sup>3</sup> /h	Code
		A	B			
DN15	16mm	39	183	0.485	17.00	134021
DN15	20mm	39	183	0.504	17.00	134022
DN20	26mm	50	210	0.863	41.00	134023
DN25	32mm	55	243	1.303	70.00	134024

Temperature range -10°C to +95°C

### MLH500EL

#### Chrome plated brass quarter turn lever ball valve with extended stem

Flat face union connections for multi-layer tube

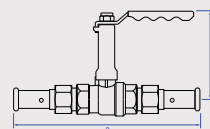

Valve Size	Connection Size	Dimensions in mm		Weight kg	Kv m <sup>3</sup> /h	Code
		A	B			
DN15	16mm	78	184	0.552	17.00	134031
DN15	20mm	78	183	0.570	17.00	134032
DN20	26mm	97	210	0.963	41.00	134033
DN25	32mm	101	243	1.140	70.00	134034

Temperature range -10°C to +95°C

### MLH550

#### DZR Brass quarter turn lever ball valve

Flat face union connections for multi-layer tube



Valve Size	Connection Size	Dimensions in mm		Weight kg	Kv m <sup>3</sup> /h	Code
		A	B			
DN15	16mm	39	183	0.485	17.00	134041
DN15	20mm	39	183	0.504	17.00	134042
DN20	26mm	50	210	0.863	41.00	134043
DN25	32mm	55	243	1.303	70.00	134044

Temperature range -10°C to +95°C

Kv = flow rate m<sup>3</sup> per hour at a pressure drop of 1 bar

# PEGLER VALVES WITH HENCO MULTI-LAYER CONNECTIONS

### MLH550EL DZR Brass quarter turn lever ball valve with extended stem

Flat face union connections for multi-layer tube

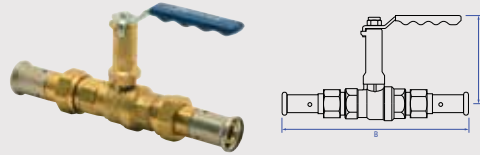

Valve Size	Connection Size	Dimensions in mm		Weight kg	Kv m <sup>3</sup> /h	Code
		A	B			
DN15	16mm	78.3	184	0.552	17.00	134051
DN15	20mm	78.3	183	0.570	17.00	134052
DN20	26mm	97.0	210	0.963	41.00	134053
DN25	32mm	101.0	243	1.140	70.00	134054

Temperature range -10°C to +95°C

### HENCO MULTI-LAYER PRESS-FIT GATE VALVES - PVDF RANGE

### MLH1070/125 Bronze full way gate valve

Flat face union connections for multi-layer tube

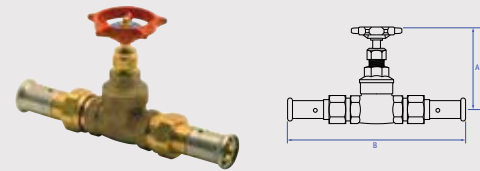

Valve Size	Connection Size	Dimensions in mm		Weight kg	Kv m <sup>3</sup> /h	Code
		A	B			
DN15	16mm	85	176	0.575	14.00	134001
DN15	20mm	85	175	0.593	14.00	134002
DN20	26mm	95	193	0.876	32.00	134003
DN25	32mm	110	228	1.380	57.00	134004

Temperature range -10°C to +95°C

### MLH1070/125LS Bronze full way gate valve with lockshield

Flat face union connections for multi-layer tube

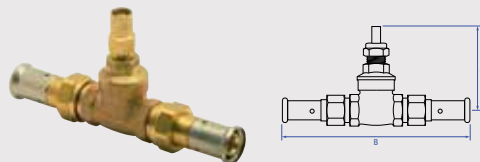

Valve Size	Connection Size	Dimensions in mm		Weight kg	Kv m <sup>3</sup> /h	Code
		A	B			
DN15	16mm	75	176	0.552	14.00	134014
DN15	20mm	75	176	0.570	14.00	134015
DN20	26mm	85	193	1.342	32.00	134017
DN25	32mm	100	228	0.891	57.00	135016

Temperature range -10°C to +95°C

Kv = flow rate m<sup>3</sup> per hour at a pressure drop of 1 bar



## MLH1068 Brass full way gate valve

Flat face union connections for multi-layer tube

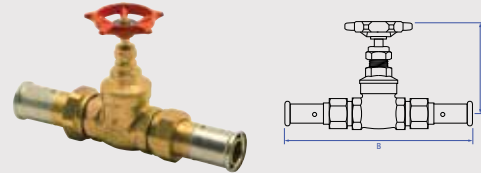

Valve Size	Connection Size	Dimensions in mm		Weight kg	Kv m <sup>3</sup> /h	Code
		A	B			
DN15	16mm	85	176	0.575	14.00	134061
DN15	20mm	85	175	0.593	14.00	134062
DN20	26mm	95	193	0.876	32.00	134063
DN25	32mm	110	228	1.380	57.00	134064

Temperature range -10°C to +95°C

## MLH1068LS Brass full way gate valve with lockshield

Flat face union connections for multi-layer tube

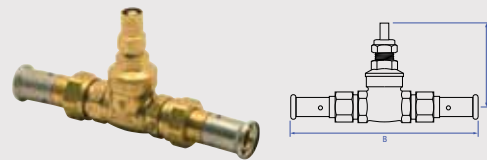

Valve Size	Connection Size	Dimensions in mm		Weight kg	Kv m <sup>3</sup> /h	Code
		A	B			
DN15	16mm	75	176	0.552	14.00	134071
DN15	20mm	75	176	0.570	14.00	134072
DN20	26mm	85	193	0.891	32.00	134073
DN25	32mm	100	228	1.342	57.00	134074

Temperature range -10°C to +95°C

## MLH1078 DZR Brass full way gate valve

Flat face union connections for multi-layer tube

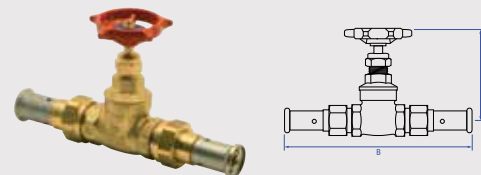

Valve Size	Connection Size	Dimensions in mm		Weight kg	Kv m <sup>3</sup> /h	Code
		A	B			
DN15	16mm	85	176	0.575	14.00	134081
DN15	20mm	85	174	0.593	14.00	134082
DN20	26mm	95	193	0.876	32.00	134083
DN25	32mm	110	228	1.380	57.00	134084

Temperature range -10°C to +95°C

Kv = flow rate m<sup>3</sup> per hour at a pressure drop of 1 bar

# PEGLER VALVES WITH HENCO MULTI-LAYER CONNECTIONS

### MLH1078LS DZR Brass full way gate valve with lockshield

Flat face union connections for multi-layer tube

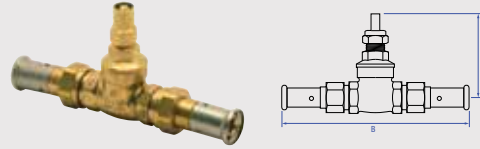

Valve Size	Connection Size	Dimensions in mm		Weight kg	Kv m <sup>3</sup> /h	Code
		A	B			
DN15	16mm	75	176	0.552	14.00	134091
DN15	20mm	75	176	0.570	14.00	134092
DN20	26mm	85	193	0.891	32.00	134093
DN25	32mm	100	228	1.342	57.00	134094

Temperature range -10°C to +95°C

### HENCO MULTI-LAYER PRESS-FIT CHECK VALVES - PVDF RANGE

### MLH4426 DZR Brass double check valve to EN 13959:2004 Type E D

Flat face union connections for multi-layer tube



Valve Size	Connection Size	Dimensions in mm		Weight kg	Code
		A	B		
DN15	16mm	15	202	0.413	134130
DN15	20mm	15	202	0.432	134131
DN20	26mm	18	236	0.677	134132
DN25	32mm	22	270	1.088	134133

Temperature range -10°C to +95°C

### HENCO MULTI-LAYER PRESS-FIT STRAINERS - PVDF RANGE

### MLH913 Bronze Y pattern strainer

Flat face union connections for multi-layer tube

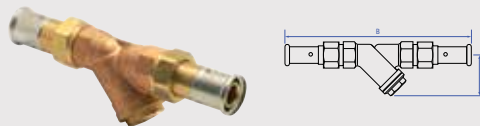

Valve Size	Connection Size	Dimensions in mm		Weight kg	Code
		A	B		
DN15	16mm	186	44	0.458	134120
DN15	20mm	185	44	0.476	134121
DN20	26mm	212.3	47	0.750	134122
DN25	32mm	243	58	1.145	134123

Temperature range -10°C to +95°C

Kv = flow rate m<sup>3</sup> per hour at a pressure drop of 1 bar



## HENCO MULTI-LAYER PRESS-FIT BALL VALVES - BRASS RANGE

### MLC500 Chrome plated brass quarter turn lever ball valve

Flat face union connections for multi-layer tube

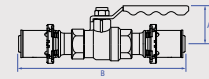

Valve Size	Connection Size	Dimensions in mm		Weight kg	Kv m <sup>3</sup> /h	Code
		A	B			
DN15	16mm	39	179	0.408	17.00	135021
DN15	20mm	39	179	0.420	17.00	135022
DN20	26mm	50	200	0.734	41.00	135023
DN25	32mm	55	206	1.193	70.00	135024
DN32	40mm	62	225	1.892	121.00	135025

Temperature range -10°C to +95°C

### MLC500EL Chrome plated brass quarter turn lever ball valve with extended stem

Flat face union connections for multi-layer tube

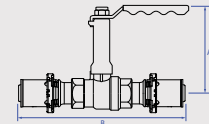

Valve Size	Connection Size	Dimensions in mm		Weight kg	Kv m <sup>3</sup> /h	Code
		A	B			
DN15	16mm	78.3	172	0.407	17.00	135031
DN15	20mm	78.3	172	0.429	17.00	135032
DN20	26mm	97	188	0.707	41.00	135033
DN25	32mm	101	206	1.302	70.00	135034
DN32	40mm	108	277	2.107	121.00	135035

Temperature range -10°C to +95°C

### MLC550 DZR brass quarter turn lever ball valve

Flat face union connections for multi-layer tube



Valve Size	Connection Size	Dimensions in mm		Weight kg	Kv m <sup>3</sup> /h	Code
		A	B			
DN15	16mm	39	179	0.408	17.00	135041
DN15	20mm	39	179	0.420	17.00	135042
DN20	26mm	50	200	0.734	41.00	135043
DN25	32mm	55	206	1.193	70.00	135044
DN32	40mm	62	225	1.892	121.00	135045

Temperature range -10°C to +95°C

Kv = flow rate m<sup>3</sup> per hour at a pressure drop of 1 bar



# PEGLER VALVES WITH HENCO MULTI-LAYER CONNECTIONS

### MLC550EL DZR Brass quarter turn lever ball valve with extended stem

Flat face union connections for multi-layer tube

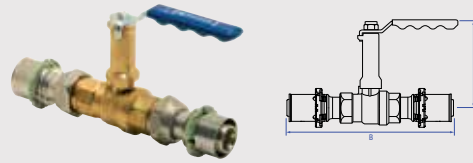

Valve Size	Connection Size	Dimensions in mm		Weight kg	Kv m <sup>3</sup> /h	Code
		A	B			
DN15	16mm	78.3	172	0.407	17.00	135051
DN15	20mm	78.3	172	0.429	17.00	135052
DN20	26mm	97	188	0.707	41.00	135053
DN25	32mm	101	206	1.302	70.00	135054
DN32	40mm	108	277	2.107	121.00	135055

Temperature range -10°C to +95°C

### HENCO MULTI-LAYER PRESS-FIT GATE VALVES - BRASS RANGE

### MLC1070/125 Bronze full way gate valve

Flat face union connections for multi-layer tube

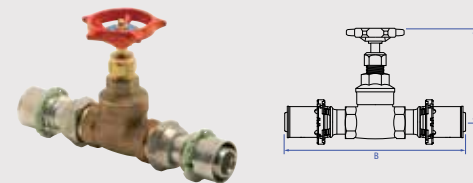

Valve Size	Connection Size	Dimensions in mm		Weight kg	Kv m <sup>3</sup> /h	Code
		A	B			
DN15	16mm	85	172	0.489	14.00	135001
DN15	20mm	85	172	0.511	14.00	135002
DN20	26mm	95	177	0.770	32.00	135003
DN25	32mm	110	186	1.270	57.00	135004
DN32	40mm	125	203	1.981	90.00	135005

Temperature range -10°C to +95°C

### MLC1070/125LS Bronze full way gate valve with lockshield

Flat face union connections for multi-layer tube

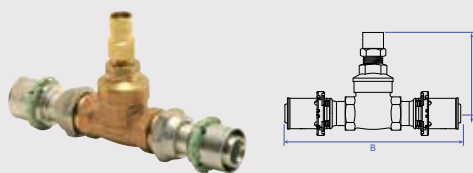

Valve Size	Connection Size	Dimensions in mm		Weight kg	Kv m <sup>3</sup> /h	Code
		A	B			
DN15	16mm	85	172	0.466	14.00	135010
DN15	20mm	85	172	0.488	14.00	135011
DN20	26mm	95	177	0.762	32.00	135012
DN25	32mm	110	187	1.232	57.00	135013
DN32	40mm	125	203	1.938	90.00	135014

Temperature range -10°C to +95°C

Kv = flow rate m<sup>3</sup> per hour at a pressure drop of 1 bar



## MLC1068 Brass full way gate valve

Flat face union connections for multi-layer tube

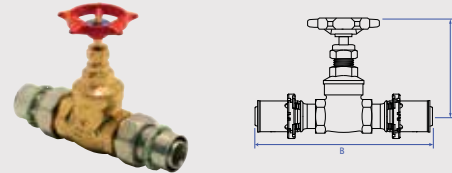

Valve Size	Connection Size	Dimensions in mm		Weight kg	Kv m <sup>3</sup> /h	Code
		A	B			
DN15	16mm	85	172	0.489	14.00	135061
DN15	20mm	85	172	0.511	14.00	135062
DN20	26mm	95	177	0.770	32.00	135063
DN25	32mm	110	186	1.270	57.00	135064
DN32	40mm	125	203	1.981	90.00	135065

Temperature range -10°C to +95°C

## MLC1068LS Brass full way gate valve with lockshield

Flat face union connections for multi-layer tube

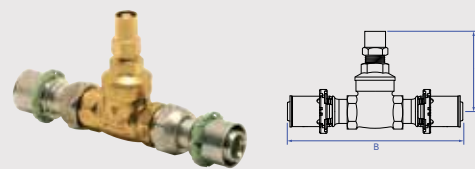

Valve Size	Connection Size	Dimensions in mm		Weight kg	Kv m <sup>3</sup> /h	Code
		A	B			
DN15	16mm	85	172	0.466	14.00	135071
DN15	20mm	85	172	0.488	14.00	135072
DN20	26mm	95	177	0.762	32.00	135073
DN25	32mm	110	187	1.232	57.00	135074
DN32	40mm	125	203	1.938	90.00	135075

Temperature range -10°C to +95°C

## MLC1078 DZR Brass full way gate valve

Flat face union connections for multi-layer tube

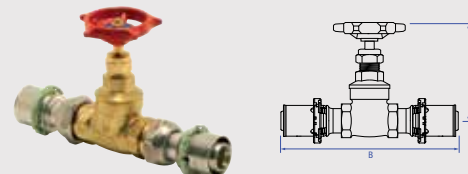

Valve Size	Connection Size	Dimensions in mm		Weight kg	Kv m <sup>3</sup> /h	Code
		A	B			
DN15	16mm	85	172	0.489	14.00	135081
DN15	20mm	85	172	0.511	14.00	135082
DN20	26mm	95	177	0.770	32.00	135083
DN25	32mm	110	186	1.270	57.00	135084
DN32	40mm	125	203	1.981	90.00	135085

Temperature range -10°C to +95°C

Kv = flow rate m<sup>3</sup> per hour at a pressure drop of 1 bar

# PEGLER VALVES WITH HENCO MULTI-LAYER CONNECTIONS

### MLC1078LS DZR Brass full way gate valve with lockshield

Flat face union connections for multi-layer tube

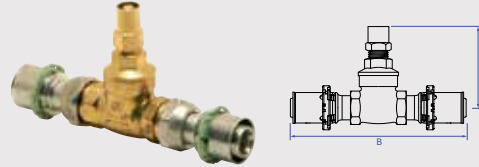

Valve Size	Connection Size	Dimensions in mm		Weight kg	Kv m <sup>3</sup> /h	Code
		A	B			
DN15	16mm	85	172	0.466	14.00	135091
DN15	20mm	85	172	0.488	14.00	135092
DN20	26mm	95	177	0.762	32.00	135093
DN25	32mm	110	187	1.232	57.00	135094
DN32	40mm	125	203	1.938	90.00	135095

Temperature range -10°C to +95°C

### HENCO MULTI-LAYER PRESS-FIT CHECK VALVES - BRASS RANGE

### MLC4426 DZR Brass double check valve to EN 13959:2004 Type E D

Flat face union connections for multi-layer tube



Valve Size	Connection Size	Dimensions in mm		Weight kg	Code
		A	B		
DN15	16mm	15	179	0.268	135131
DN15	20mm	15	179	0.290	135132
DN20	26mm	18	213	0.429	135133
DN25	32mm	22	228	0.978	135134
DN32	40mm	27	260	1.540	135135

Temperature range -10°C to +95°C

### HENCO MULTI-LAYER PRESS-FIT STRAINERS - BRONZE RANGE

### MLC913 Bronze Y pattern strainer

Flat face union connections for multi-layer tube

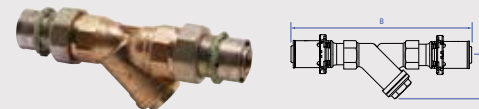

Valve Size	Connection Size	Dimensions in mm		Weight kg	Code
		A	B		
DN15	16mm	44	163	0.317	135121
DN15	20mm	44	163	0.339	135122
DN20	26mm	47	190	0.503	135123
DN25	32mm	58	201	1.034	135124
DN32	40mm	68	243	1.675	135125

Temperature range -10°C to +95°C

Kv = flow rate m<sup>3</sup> per hour at a pressure drop of 1 bar

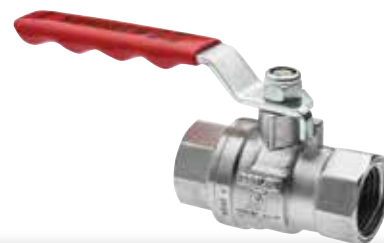

## CHROME PLATED THREADED QUARTER TURN BALL VALVES

**PB700\*****Chrome plated brass full bore ball valve**

Yellow lever handle

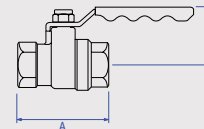

Valve Size	Dimensions in mm		Weight kg	Kv m <sup>3</sup> /h	Cv-US GPM	Kv Gas	Code
	A	B					
<b>ISO 7 Rc taper thread</b>							
1/4"	48	35	0.16	5.90	-	3.80	230001
3/8"	49	35	0.16	9.40	-	4.20	230002
1/2"	59	39	0.24	17.00	-	11.30	230003
3/4"	67.5	50	0.44	41.00	-	23.80	230004
1"	79.5	55	0.64	70.00	-	31.10	230005
1 1/4"	95	62	1.01	121.00	-	67.20	230006
1 1/2"	100	77.5	1.42	200.00	-	101.50	230007
2"	124.5	88	2.38	292.00	-	148.00	230008
2 1/2"	150	97	4.14	535.00	-	-	230009
3"	177	122	6.71	850.00	-	-	230010
4"	214	136	10.98	1360.00	-	-	230011
<b>American NPT taper thread (AT)</b>							
1/4"	48	35	0.16	5.90	6.90	-	230061
3/8"	49	35	0.16	9.40	11.00	-	230062
1/2"	59	39	0.24	17.00	19.90	-	230063
3/4"	67.5	50	0.44	41.00	48.00	-	230064
1"	79.5	55	0.64	70.00	81.90	-	230065
1 1/4"	95	62	1.01	121.00	141.60	-	230066
1 1/2"	100	77.5	1.42	200.00	234.00	-	230067
2"	124.5	88	2.38	292.00	341.00	-	230068
2 1/2"	150	97	4.14	535.00	626.00	-	230069
3"	177	122	6.71	850.00	994.50	-	230070
4"	214	136	10.98	1360.00	1591.20	-	230071

Temperature range: -10°C to +186°C Gas application: -20°C to +60°C maximum 5bar (MOP5)

Gas families 1,2,3\*  
Tested to EN 331:1998 + A1:2010 1/4" - 2"**PB700T\*****Chrome plated brass full bore ball valve**

Yellow tee handle, PN40

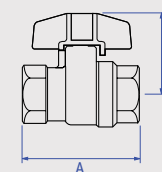

Valve Size	Dimensions in mm		Weight kg	Kv m <sup>3</sup> /h	Kv Gas	Code
	A	B				
<b>ISO 7 Rc taper thread</b>						
1/4"	48	36.5	0.14	5.90	3.80	231001
3/8"	48.5	36.5	0.26	9.40	4.20	231002
1/2"	59	40	0.27	17.00	11.30	231003
3/4"	67.5	50.5	0.49	41.00	23.80	231004
1"	79.5	55	0.72	70.00	31.10	231005

Temperature range: -10°C to +186°C Gas application: -20°C to +60°C maximum 5bar (MOP5)

Gas families 1,2,3\*  
Tested to EN 331:1998 + A1:2010

Kv = flow rate m<sup>3</sup> per hour at a pressure drop of 1 bar  
 Kv Gas = flow rate in m<sup>3</sup> per hour at a pressure drop of 1mbar  
 Cv = flow rate in US GPM at a pressure drop of 1psi

### PB500 Chrome plated brass full bore ball valve

Red lever handle, PN25

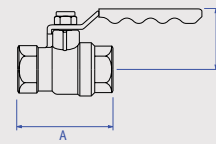

Valve Size	Dimensions in mm		Weight kg	Kv m <sup>3</sup> /h	Cv-US GPM	Code
	A	B				
<b>ISO 7 Rc taper thread</b>						
1/4"	48	35	0.15	5.90	-	242001
3/8"	48.5	35	0.15	9.40	-	242002
1/2"	59	39	0.23	17.00	-	242003
3/4"	67.5	50	0.40	41.00	-	242004
1"	79.5	55	0.61	70.00	-	242005
1 1/4"	95	62	0.95	121.00	-	242006
1 1/2"	100	77.5	1.33	200.00	-	242007
2"	124	88	2.18	292.00	-	242008
2 1/2"	150	97	3.75	535.00	-	242009
3"	177	122	6.20	850.00	-	242010
4"	214	136	10.45	1360.00	-	242011
<b>ISO 228 (BS 2779) parallel thread (PT)</b>						
3/8"	48.5	35	0.15	9.40	-	242022
1/2"	59	39	0.23	17.00	-	242023
3/4"	67.5	50	0.40	41.00	-	242024
1"	79.5	55	0.61	70.00	-	242025
1 1/4"	95	62	0.95	121.00	-	242026
1 1/2"	100	77.5	1.33	200.00	-	242027
2"	124	88	2.18	292.00	-	242028
2 1/2"	150	97	3.75	535.00	-	242029
3"	177	122	6.20	850.00	-	242030
4"	214	136	10.98	1360.00	-	242031
<b>American NPT taper thread (AT)</b>						
1/2"	59	39	0.23	17.00	19.90	242043
3/4"	67.5	50	0.40	41.00	48.00	242044
1"	79.5	55	0.61	70.00	81.90	242045
1 1/4"	95	62	0.95	121.00	141.60	242046
1 1/2"	100	77.5	1.33	200.00	234.00	242047
2"	124	88	2.18	292.00	341.60	242048
2 1/2"	150	97	3.75	535.00	626.00	242049
3"	177	122	6.20	850.00	994.50	242050
4"	214	136	10.45	1360.00	1591.20	242051

Temperature range: -10°C to +150°C

### PB500\* Chrome plated brass full bore ball valve

Yellow lever handle, PN25

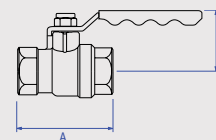

Valve Size	Dimensions in mm		Weight kg	Kv m <sup>3</sup> /h	Kv Gas	Cv-US GPM	Code
	A	B					
<b>ISO 7 Rc taper thread</b>							
1/4"	48	35	0.15	5.90	3.80	-	242101
3/8"	48.5	35	0.15	9.40	4.20	-	242102
1/2"	59	39	0.23	17.00	11.30	-	242103
3/4"	67.5	50	0.40	41.00	23.80	-	242104

Kv = flow rate m<sup>3</sup> per hour at a pressure drop of 1 bar  
 Kv Gas = flow rate in m<sup>3</sup> per hour at a pressure drop of 1mbar  
 Cv = flow rate in US GPM at a pressure drop of 1psi



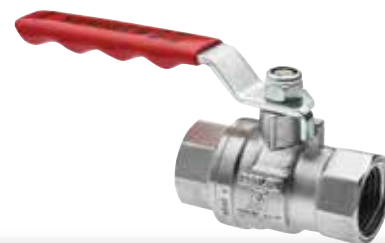

## PB500\* - Continued

1"	79.5	55	0.61	70.00	31.10	-	242105
1 1/4"	95	62	0.95	121.00	67.20	-	242106
1 1/2"	100	77.5	1.33	200.00	101.50	-	242107
2"	124	88	2.18	292.00	148.00	-	242108
2 1/2"	150	97	3.75	535.00	-	-	242109
3"	177	122	6.20	850.00	-	-	242110
4"	214	136	10.45	1360.00	-	-	242111
<b>ISO 228 (BS 2779) parallel thread (PT)</b>							
1/4"	48	35	0.15	5.90	3.80	-	242060
3/8"	48.5	35	0.15	9.40	4.20	-	242061
1/2"	59	39	0.23	17.00	11.30	-	242062
3/4"	67.5	50	0.40	41.00	23.80	-	242063
1"	79.5	55	0.61	70.00	31.10	-	242064
1 1/4"	95	62	0.95	121.00	67.20	-	242065
1 1/2"	100	77.5	1.33	200.00	101.50	-	242066
2"	124	88	2.18	292.00	148.00	-	242067
2 1/2"	150	97	3.75	535.00	-	-	242068
3"	177	122	6.20	850.00	-	-	242069
4"	214	136	10.45	1360.00	-	-	242070
<b>American NPT taper thread (AT)</b>							
1/4"	48	35	0.15	5.90	-	6.90	242121
3/8"	48.5	35	0.15	9.40	-	11.00	242122
1/2"	59	39	0.23	17.00	-	19.90	242123
3/4"	67.5	50	0.40	41.00	-	48.00	242124
1"	79.5	55	0.61	70.00	-	81.90	242125
1 1/4"	95	62	0.95	121.00	-	141.60	242126
1 1/2"	100	77.5	1.33	200.00	-	234.00	242127
2"	124	88	2.18	292.00	-	314.60	242128

Temperature range: -10°C to +150°C Gas application: -20°C to +60°C maximum 5bar (MOP5)

Gas families 1,2,3\*  
Tested to EN 331:1998 + A1:2010 1/4" - 2"

## PB500MF Chrome plated brass full bore ball valve

Red lever handle, male x female, ISO 228 parallel thread

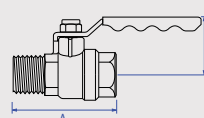

Valve Size	Connection Size	Dimensions in mm		Weight kg	Kv m <sup>3</sup> /h	Code
		A	B			
DN10	3/8"	53	35	0.155	9.40	242150
DN15	1/2"	57	39	0.218	17.00	242151
DN20	3/4"	69	50	0.382	41.00	242152
DN25	1"	81	55	0.574	70.00	242153
DN32	1 1/4"	97	62	0.891	121.00	242154
DN40	1 1/2"	103	78	1.272	200.00	242155
DN50	2"	127	84	2.074	292.00	242156

Temperature range: -10°C to +150°C

Kv = flow rate m<sup>3</sup> per hour at a pressure drop of 1 bar  
Kv Gas = flow rate in m<sup>3</sup> per hour at a pressure drop of 1mbar  
Cv = flow rate in US GPM at a pressure drop of 1psi

### PB500MF T Chrome plated brass full bore ball valve

Red tee handle, male x female, ISO 228 parallel thread

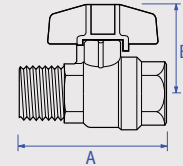

Valve Size	Connection Size	Dimensions in mm		Weight kg	Kv m <sup>3</sup> /h	Code
		A	B			
DN10	3/8"	53	37	0.137	9.40	242160
DN15	1/2"	57	40	0.197	17.00	242161
DN20	3/4"	69	51	0.356	41.00	242162
DN25	1"	81	55	0.555	70.00	242163

Temperature range: -10°C to +150°C

### PB500DC Chrome plated brass full bore brass ball valve with drain cock

Red lever handle, ISO 228 parallel thread

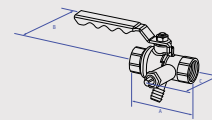

Valve Size	Connection Size	Dimensions in mm			Weight kg	Kv m <sup>3</sup> /h	Code
		A	B	C			
DN15	1/2"	68	40	51	0.319	17.00	242166
DN20	3/4"	76	50	51	0.504	41.00	242167
DN25	1"	88	55	60	0.707	70.00	242168

Temperature range: -10°C to +150°C

### PB500T Chrome plated brass full bore ball valve

Red tee handle, PN25, ISO 228 (BS 2779) parallel thread (PT)

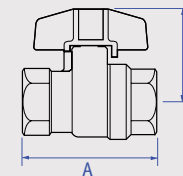

Valve Size	Dimensions in mm		Weight kg	Kv m <sup>3</sup> /h	Code
	A	B			
1/4"	48	36.5	0.15	5.90	243021
3/8"	48.5	36.5	0.15	9.40	243022
1/2"	59	40	0.22	17.00	243023
3/4"	67.5	50.5	0.38	41.00	243024
1"	79.5	55	0.58	70.00	243025

Temperature range: -10°C to +150°C

### PB500EL Chrome plated brass full bore ball valve

Red extended lever handle, PN25, ISO 7 Rc taper thread

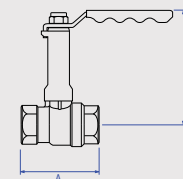

Valve Size	Dimensions in mm		Weight kg	Kv m <sup>3</sup> /h	Code
	A	B			
1/2"	59	78.3	0.30	17.00	245003
3/4"	67.5	97	0.51	41.00	245004
1"	79.5	101	0.70	70.00	245005

Kv = flow rate m<sup>3</sup> per hour at a pressure drop of 1 bar

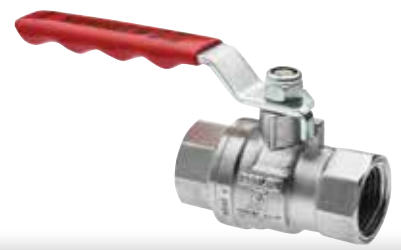

## PB500EL- Continued

1 1/4"	95	108	1.04	121.00	245006
1 1/2"	100	128	1.50	200.00	245007
2"	124.5	146.2	2.44	292.00	245008

Temperature range: -10°C to +150°C

## DZR THREADED BALL VALVES

### PB550DR Full bore DZR lever ball valve

Blue lever handle, female ends, PN25, ISO 7 Rc taper thread

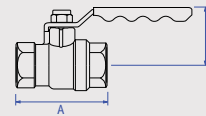

Valve Size	Dimensions in mm		Weight kg	Kv m <sup>3</sup> /h	Code
	A	B			
1/2"	59	39	0.23	17.00	245201
3/4"	68	51	0.41	41.00	245202
1"	80	56	0.61	70.00	245203
1 1/4"	95	63	0.94	121.00	245204
1 1/2"	100	78	1.33	200.00	245205
2"	124	88	2.21	292.00	245206
<b>ISO 228 (BS 2779) parallel thread (PT)</b>					
1/2"	59	39	0.23	17.00	245150
3/4"	68	51	0.41	41.00	245151
1"	80	56	0.61	70.00	245152
1 1/4"	95	63	0.94	121.00	245153
1 1/2"	100	78	1.33	200.00	245154
2"	124	88	2.21	292.00	245155

Temperature range: -10°C to +150°C

### PB550DR DZR Brass full bore ball valve

Blue tee handle, female ends, PN25, ISO 7 Rc taper thread

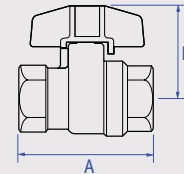

Valve Size	Dimensions in mm		Weight kg	Kv m <sup>3</sup> /h	Code
	A	B			
1/2"	59	39	0.22	17.00	245211
3/4"	68	51	0.38	41.00	245212
1"	80	56	0.58	70.00	245213

Temperature range: -10°C to +150°C

### PB550DR LS DZR Brass full bore ball valve with lockshield

PN25, ISO 7 Rc taper thread

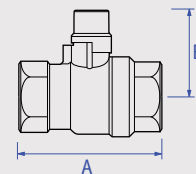

Valve Size	Dimensions in mm		Weight kg	Kv m <sup>3</sup> /h	Code
	A	B			
1/2"	59	45	0.21	17.00	245260
3/4"	68	53	0.37	41.00	245261

Kv = flow rate m<sup>3</sup> per hour at a pressure drop of 1 bar

### PB550DR LS - Continued

1"	80	58	0.57	70.00	245262
1 1/4"	95	65	1.15	212.00	245263
1 1/2"	100	81	1.21	200.00	245264
2"	124	88	2.79	292.00	245265

Temperature range: -10°C to +150°C

### PB550DR EL DZR Brass full bore ball valve

Blue lever handle, PN25, ISO 7 Rc taper thread

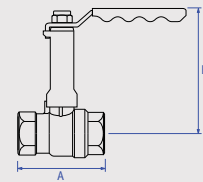

Valve Size	Dimensions in mm		Weight kg	Kv m <sup>3</sup> /h	Code
	A	B			
1/2"	59	78.3	0.30	17.00	245283
3/4"	68	97	0.51	41.00	245284
1"	80	101	0.70	70.00	245285
1 1/4"	95	108	1.04	212.00	245286
1 1/2"	100	128	1.50	200.00	245287
2"	124	146.2	2.44	292.00	245288

Temperature range: -10°C to +150°C

### CHROME PLATED THREADED QUARTER TURN BALL VALVES

### PB100\* Chromium plated brass full bore ball valve

Red lever handle, PN25 to 2", PN16 2 1/2", 3" and 4"

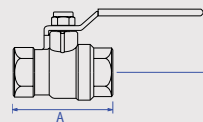

Valve Size	Dimensions in mm		Weight kg	Kv m <sup>3</sup> /h	Cv-US GPM	Code
	A	B				
<b>BS21 7 taper thread</b>						
1/2"	50	46	0.18	17.00	-	270001
3/4"	58	50	0.25	41.00	-	270002
1"	69	52	0.38	70.00	-	270003
1 1/4"	81	70	0.628	121.00	-	270004
1 1/2"	89	76	0.84	200.00	-	270005
2"	110	83	1.45	292.00	-	270006
2 1/2" (PN16)	136	109	3.000	535.00	-	270007
3" (PN16)	163	119	4.500	850.00	-	270008
4" (PN16)	192	155	7.500	1360.00	-	270009
<b>ISO 228 (BS2779) parallel thread (PT)</b>						
1/2"	50	46	0.18	17.00	-	270021
3/4"	58	50	0.25	41.00	-	270022
1"	69	52	0.38	70.00	-	270023
1 1/4"	81	70	0.628	121.00	-	270024
1 1/2"	89	76	0.84	200.00	-	270025
2"	110	83	1.45	292.00	-	270026
2 1/2"	136	109	3.00	535.00	-	270027
3"	163	119	4.500	850.00	-	270028
4"	192	155	7.500	1360.00	-	270029
<b>ANSI (NPT) American taper thread (AT)</b>						
1/2"	50	46	0.18	17.00	19.90	270041
3/4"	58	50	0.25	41.00	48.00	270042
1"	69	52	0.38	70.00	81.90	270043

Kv = flow rate m<sup>3</sup> per hour at a pressure drop of 1 bar  
Cv = flow rate in US GPM at a pressure drop of 1psi

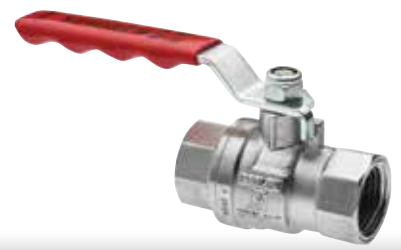

## PB100\* - Continued

1 1/4"	81	70	0.628	121.00	141.60	270044
1 1/2"	89	76	0.84	200.00	234.00	270045
2"	110	83	1.45	292.00	341.60	270046
2 1/2" (PN16)	136	109	3.000	535.00	626.00	270047
3" (PN16)	163	119	4.500	850.00	994.50	270048
4" (PN16)	192	155	7.500	1360.00	1591.20	270049

Temperature range: -10°C to +150°C

\*PBSEK, LD and PDK are not suitable for fixing to this range

## CHROME PLATED THREADED BIBTAPS

### PB50HU Chrome plated hose union ball type bibtap

Red lever

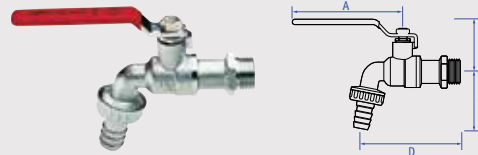

Valve Size	Dimensions in mm				Weight kg	Kv m <sup>3</sup> /h	Code
	A	B	C	D			
1/2"	98	45	45	89	0.26	9.40	262001
3/4"	98	45	50	94	0.32	17.00	262002

### PB50 Chrome plated ball type bibtap with 3/4" American thread on nose

Red lever

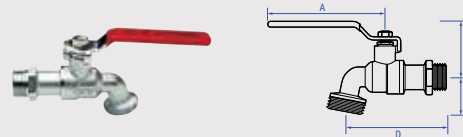

Valve Size	Dimensions in mm				Weight kg	Cv	Code
	A	B	C	D			
1/2"	98	45	45	86	0.22	9.40	262003

### PB50AT HU Chrome plated ball type bibtap 14mm diameter hose coupling, American thread

Red lever

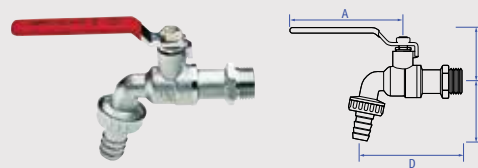

Valve Size	Dimensions in mm				Weight kg	Kv m <sup>3</sup> /h	Code
	A	B	C	D			
1/2"	98	45	45	89	0.26	9.40	262004

### PB52HU Chrome plated brass hose union ball type bibtap

Lockable in closed position



Valve Size	Dimensions in mm				Weight kg	Kv m <sup>3</sup> /h	Code
	A	B	C	D			
1/2"	88	45	48	105	0.28	9.40	262021
3/4"	88	45	50	105	0.36	17.00	262022

Kv = flow rate m<sup>3</sup> per hour at a pressure drop of 1 bar  
Cv = flow rate in US GPM at a pressure drop of 1psi

### BRASS THREE WAY VENT VALVES

#### 1111BV

#### Brass three way vent valve

T port, ISO 228 parallel threads, PN25, nickel plated



Valve Size	Dimensions in mm		Weight kg	Kv m <sup>3</sup> /h	Code
	A	B			
1"	80	60	0.65	70.00	245100
1 1/4"	91	67	1.14	121.00	245101
1 1/2"	107	75	1.65	200.00	245102
2"	134	95	3.20	292.00	245103

### DZR THREADED COMBI BALL VALVES AND STRAINERS

#### PB560

#### DZR combi ball valve and strainer with tee handle

PN20, ISO 7 Rc taper thread

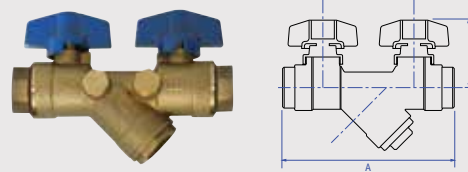

Valve Size	Dimensions in mm		Weight kg	Code
	A	B		
3/4" blue tee	143	52	0.86	245500
3/4" red tee	143	52	0.86	245501

Temperature range: -10°C to +150°C

#### PB560EXT

#### DZR combi ball valve and strainer with extended tee handle

PN20, ISO 7 Rc taper thread

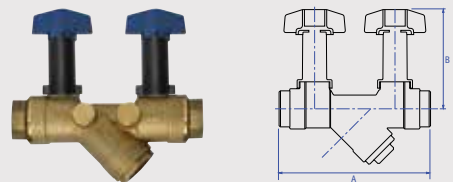

Valve Size	Dimensions in mm		Weight kg	Code
	A	B		
3/4" blue tee	143	99	0.95	245502
3/4" red tee	143	99	0.95	245503

Temperature range: -10°C to +150°C

### BALLOMAX STEEL THREADED BALL VALVES

#### PB1000

#### Ballomax steel ball valve

BSP parallel female ends, standard PN40, lever operated

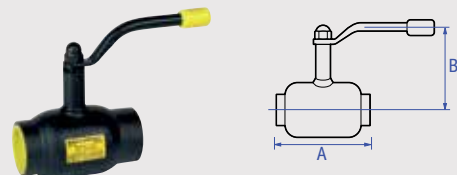

Valve Size	Dimensions in mm		Weight kg	Kv m <sup>3</sup> /h	Code
	A	B			
1/2" x 1/2" 64100015	65	116	0.60	6.00	13951
3/4" x 3/4" 64100020	75	115	0.70	20.00	13952
1" x 1" 64100025	90	120	0.90	26.00	13953
1 1/4" x 1 1/4" 64100032	105	124	1.20	43.00	13954



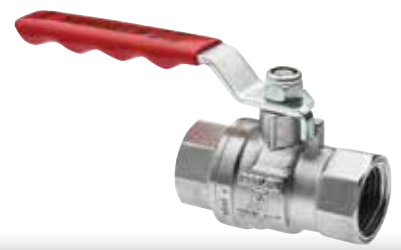

## PB1000 - Continued

1 1/2" x 11/2" 64100040	120	129	1.90	64.00	13955
2" x 2" 64100050	145	135	2.90	100.00	13956

## PB1001 Ballomax steel ball valve

BSP parallel female thread x weld, standard PN40, lever operated

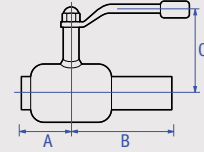

Valve Size	Dimensions in mm			Weight kg	Kv m <sup>3</sup> /h	Code
	A	B	C			
1/2" x 1/2" 61101015	33	105	116	0.70	6.00	13957
3/4" x 3/4" 64101020	38	115	115	0.80	20.00	13962
1" x 1" 64101025	45	115	120	0.90	26.00	13958
1 1/4" x 11/4" 64101032	53	139	124	1.30	43.00	13959
1 1/2" x 11/2" 64101040	60	130	129	2.00	64.00	13960
2" x 2" 64101050	73	150	135	2.90	100.00	13961

#### Ballofix isolating ball valve – threaded

Female x female, screwdriver operation, raw finish

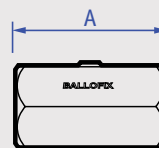

Valve Size	Pattern No.	Dimensions in mm	Weight kg	Code
		A		
1/2"	3350YA	47	0.11	13532
3/4"	3450YA	56	0.23	13559
1"	3550YA	75	0.42	13573

#### Ballofix isolating ball valve – threaded

Female x female, screwdriver operation, chrome plated

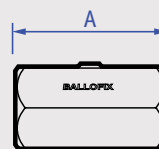

Valve Size	Pattern No.	Dimensions in mm	Weight kg	Code
		A		
1/2"	3205ZA	47	0.11	13535

#### Ballofix drain cock

Screwdriver operation



Valve Size	Pattern No.	Dimensions in mm	Weight kg	Code
		A		
1/2"	5095BA Nickel	31	0.08	13175
1/2"	5095CA Chrome Plated	31	0.08	13176

#### Ballofix isolating ball valve – straight pattern

RP female ends, key lock and hexagon key operation, brass, raw finish

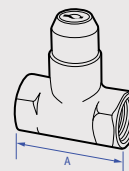

Valve Size	Pattern No.	Dimensions in mm	Weight kg	Code
		A		
1/2"	3355BK	57	0.23	13219
3/4"	3455BK	62	0.36	13360
1"	3555BK	75.5	0.56	13443
1 1/2"	3755BK	98	1.23	13222
2"	3855BK	115	2.28	13223

Temperature range: -10°C to +150°C

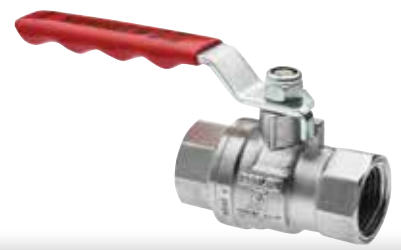

### Ballofix isolating ball valve – threaded

Male x female, plastic lever operation, raw finish

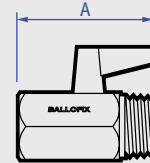

Valve Size	Pattern No.	Dimensions in mm	Weight kg	Code
		A		
1/2" x 1/2"	3310YP	44	0.10	13226

### BALLOFIX DZR THREADED ISOLATING BALL VALVES

### Ballofix radiator valve – straight pattern

BSP parallel female thread x male iron union, screwdriver operation, raw finish

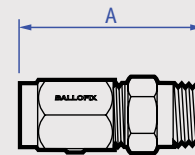

Valve Size	Pattern No.	Dimensions in mm	Weight kg	Code
		A		
3/4"	5060BA	82	0.37	13367

### Ballofix isolating ball valve – threaded

Male x female, screwdriver operation, raw finish

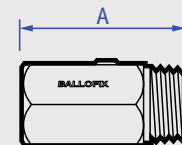

Valve Size	Pattern No.	Dimensions in mm	Weight kg	Code
		A		
1/4" x 1/4"	3200YA	44	0.07	13148
3/8" x 3/8"	3210YA	45	0.06	13166
1/2" x 1/2"	3310YA	44	0.10	13538

### Ballofix isolating ball valve – threaded

Male x female, chrome plated, screwdriver operation

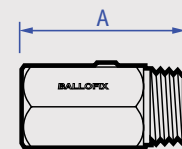

Valve Size	Pattern No.	Dimensions in mm	Weight kg	Code
		A		
1/4" x 1/4"	3200ZA	44	0.07	13151
1/2" x 1/2"	3310ZA	44	0.26	13539
3/4" x 3/4"	3410ZA	52	0.19	13377

### Ballofix isolating ball valve – threaded

Male x male, chrome plated, screwdriver operation

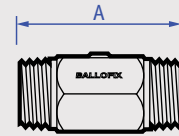

Valve Size	Pattern No.	Dimensions in mm	Weight kg	Code
		A		
1/2"	3390ZA	45	0.10	13356

### BRONZE THREADED GATE VALVES

### 1072 Bronze full way gate valve

EN 12288 series B PN32

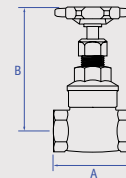

Valve Size	Dimensions in mm		Weight kg	Kv m <sup>3</sup> /h	Cv-US GPM	Code
	A	B				
ISO 7 Rc taper thread						
1/2"	64	100	0.47	14.00	-	101103
3/4"	65	110	0.69	32.00	-	101104
1"	75	130	1.02	57.00	-	101105
1 1/4"	90	145	1.57	90.00	-	101106
1 1/2"	97	165	2.44	129.00	-	101107
2"	105	200	3.43	230.00	-	101108
ISO 228 (BS 2779) parallel thread (PT)						
1/2"	64	100	0.47	14.00	-	101123
3/4"	65	110	0.69	32.00	-	101124
1"	75	130	1.02	57.00	-	101125
1 1/4"	90	145	1.57	90.00	-	101126
1 1/2"	97	165	2.44	129.00	-	101127
2"	105	200	3.43	230.00	-	101128
American NPT taper thread (AT)						
1/2"	64	100	0.47	14.00	16.40	101143
3/4"	65	110	0.69	32.00	37.40	101144
1"	75	130	1.02	57.00	66.70	101145
1 1/4"	90	145	1.57	90.00	105.30	101146
1 1/2"	97	165	2.44	129.00	150.90	101147
2"	105	200	3.43	230.00	269.10	101148

Temperature range: -10°C to +180°C

### 1070/125 Bronze full way gate valve

EN 12288 series B PN20

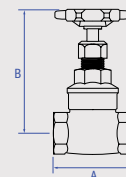

Valve Size	Dimensions in mm		Weight kg	Kv m <sup>3</sup> /h	Code
	A	B			
ISO 7 Rc taper thread					
1/2"	52	85	0.32	14.00	103007
3/4"	56	95	0.46	32.00	103008
1"	65	110	0.69	57.00	103009
1 1/4"	73	125	1.03	90.00	103010

Kv = flow rate m<sup>3</sup> per hour at a pressure drop of 1 bar

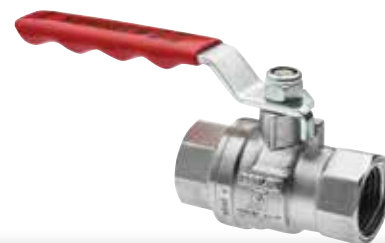

## 1070/125 - Continued

1 1/2"	76	145	1.40	129.00	103011
2"	90	170	2.28	230.00	103012
2 1/2"	102	205	3.68	428.00	103013
3"	114	240	5.42	680.00	103014
4"	134	290	10.59	1088.00	103015
<b>ISO 228 (BS 2779) parallel thread (PT)</b>					
1/2"	52	85	0.32	14.00	103047
3/4"	56	95	0.46	32.00	103048
1"	65	110	0.69	57.00	103049
1 1/4"	73	125	1.03	90.00	103050
1 1/2"	76	145	1.40	129.00	103051
2"	90	170	2.28	230.00	103052
2 1/2"	102	205	3.68	428.00	103053
3"	114	240	5.42	680.00	103054
4"	134	290	10.59	1088.00	103055

Temperature range: -10°C to +198°C. WRAS approval temperature 85°C.

## 1070/125LS Bronze full way gate valve with lockshield

EN 12288 series B PN20, ISO 7 Rc taper thread

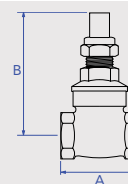

Valve Size	Dimensions in mm		Weight kg	Kv m <sup>3</sup> /h	Code
	A	B			
1/2"	52	75	0.29	14.00	103057
3/4"	56	85	0.43	32.00	103058
1"	65	100	0.67	57.00	103059
1 1/4"	73	110	0.99	90.00	103060
1 1/2"	76	130	1.30	129.00	103061
2"	90	155	2.28	230.00	103062

Temperature range: -10°C to +180°C. WRAS approval temperature 85°C.

## BRASS THREADED GATE VALVES

### 1065 Forged brass full way gate valve

17.5bar at 93°C

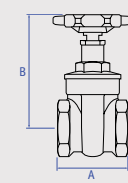

Valve Size	Dimensions in mm		Weight kg	Kv m <sup>3</sup> /h	Cv-US GPM	Code
	A	B				
<b>BS 21 Rc taper thread</b>						
1/2"	46	70	0.27	14.00	-	202007
3/4"	50	80	0.37	32.00	-	202008
1"	57	95	0.58	57.00	-	202009
1 1/4"	64	115	0.94	90.00	-	202010
1 1/2"	68	125	1.19	129.00	-	202011
2"	81	155	2.09	230.00	-	202012
<b>ISO 228 (BS 2779) parallel thread (PT)</b>						
1/2"	46	70	0.27	14.00	-	202052
3/4"	50	80	0.37	32.00	-	202053
1"	57	95	0.58	57.00	-	202054
1 1/4"	64	115	0.94	90.00	-	202055

Kv = flow rate m<sup>3</sup> per hour at a pressure drop of 1 bar

#### 1065 - Continued

1 1/2"	68	125	1.19	129.00	-	202056
2"	81	155	2.09	230.00	-	202057
<b>American NPT taper thread (AT)</b>						
1/2"	46	70	0.27	14.00	16.40	202042
3/4"	50	80	0.37	32.00	37.40	202043
1"	57	95	0.58	57.00	66.70	202044
1 1/4"	64	115	0.94	90.00	105.30	202045
1 1/2"	68	125	1.19	129.00	150.90	202046
2"	81	155	2.09	230.00	269.10	202047

#### 1068 Forged brass full way gate valve

EN 12288 series B PN20

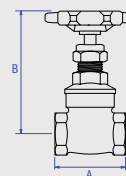

Valve Size	Dimensions in mm		Weight kg	Kv m <sup>3</sup> /h	Cv-US GPM	Code
	A	B				
<b>ISO 7 Rc taper thread</b>						
1/2"	52	85	0.32	14.00	-	203007
3/4"	56	95	0.46	32.00	-	203008
1"	65	110	0.69	57.00	-	203009
1 1/4"	73	125	1.03	90.00	-	203010
1 1/2"	76	145	1.40	129.00	-	203011
2"	90	170	2.28	230.00	-	203012
2 1/2"	102	205	3.68	428.00	-	203013
3"	114	240	5.42	680.00	-	203014
4"	134	290	10.59	1088.00	-	203015
<b>ISO 228 (BS 2779) parallel thread (PT)</b>						
1/2"	52	85	0.32	14.00	-	203047
3/4"	56	95	0.46	32.00	-	203048
1"	65	110	0.69	57.00	-	203049
1 1/4"	73	125	1.03	90.00	-	203050
1 1/2"	76	145	1.40	129.00	-	203051
2"	90	170	2.28	230.00	-	203052
2 1/2"	102	205	3.68	428.00	-	203053
3"	114	240	5.42	680.00	-	203054
<b>American NPT taper thread (AT)</b>						
1/2"	52	85	0.32	14.00	16.40	203027
3/4"	56	95	0.46	32.00	37.40	203028
1"	65	110	0.69	57.00	66.70	203029
1 1/4"	73	125	1.03	90.00	105.30	203030
1 1/2"	76	145	1.40	129.00	150.90	203031
2"	90	170	2.28	230.00	269.10	203032
2 1/2"	102	205	3.68	428.00	500.80	203033
3"	114	240	5.42	680.00	795.60	203034
4"	134	290	10.59	1088.00	1273.00	203055

Temperature range: -10°C to +180°C. WRAS approval temperature 85°C.

Kv = flow rate m<sup>3</sup> per hour at a pressure drop of 1 bar  
Cv = flow rate in US GPM at a pressure drop of 1psi



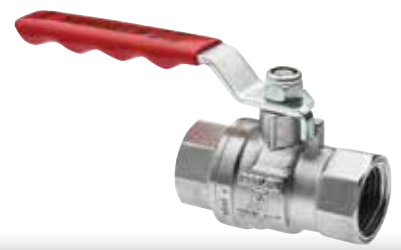

## 1068LS Forged brass full way gate valve with lockshield

EN 12288 series B PN20, ISO 7 Rc taper thread

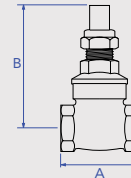

Valve Size	Dimensions in mm		Weight kg	Kv m <sup>3</sup> /h	Code
	A	B			
1/2"	52	75	0.30	14.00	203067
3/4"	56	85	0.44	32.00	203068
1"	65	100	0.71	57.00	203069
1 1/4"	73	110	1.03	90.00	203070
1 1/2"	76	130	1.32	129.00	203071
2"	90	155	2.28	230.00	203072

Temperature range: -10°C to +180°C. WRAS approval temperature 85°C.

## DZR THREADED GATE VALVES

### 1078 DZR full way gate valve

EN 12288 series B PN20, ISO 7 Rc taper thread

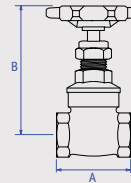

Valve Size	Dimensions in mm		Weight kg	Kv m <sup>3</sup> /h	Code
	A	B			
1/2"	52	85	0.31	14.00	204007
3/4"	56	95	0.46	32.00	204008
1"	65	110	0.72	57.00	204009
1 1/4"	73	125	1.07	90.00	204010
1 1/2"	76	145	1.33	129.00	204011
2"	90	170	2.45	230.00	204012

#### ISO 228 (BS 2779) parallel thread (PT)

1/2"	52	85	0.31	14.00	204030
3/4"	56	95	0.46	32.00	204031
1"	65	110	0.72	57.00	204032
1 1/4"	73	125	1.07	90.00	204033
1 1/2"	76	145	1.33	129.00	204034
2"	90	170	2.45	230.00	204035

Temperature range: -10°C to +180°C. WRAS approval temperature 85°C.

### 1078LS DZR full way gate valve with lockshield

EN 12288 series B PN20, ISO 7 Rc taper thread

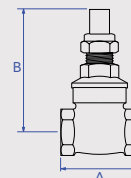

Valve Size	Dimensions in mm		Weight kg	Kv m <sup>3</sup> /h	Code
	A	B			
1/2"	52	75	0.30	14.00	204050
3/4"	56	85	0.44	32.00	204051
1"	65	100	0.71	57.00	204052
1 1/4"	73	110	1.03	90.00	204053
1 1/2"	76	130	1.32	129.00	204054
2"	90	155	2.28	230.00	204055

Temperature range: -10°C to +180°C. WRAS approval temperature 85°C.

Kv = flow rate m<sup>3</sup> per hour at a pressure drop of 1 bar  
Cv = flow rate in US GPM at a pressure drop of 1psi

#### BRONZE THREADED GLOBE VALVES

### 1029

#### Bronze globe valve

BS 5154 PN32 series B/NM, non metallic renewable disk

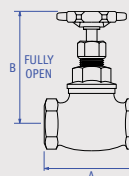

Valve Size	Dimensions in mm		Weight kg	Kv m <sup>3</sup> /h	Cv-US GPM	Code
	A	B				
<b>ISO 7 Rc taper thread</b>						
1/4"	48	76	0.20	0.70	-	110005
3/8"	46	76	0.22	1.10	-	110006
1/2"	57	95	0.38	2.00	-	110007
3/4"	65	100	0.54	5.00	-	110008
1"	78	114	0.84	10.00	-	110009
1 1/4"	89	138	1.36	16.00	-	110010
1 1/2"	100	159	1.76	23.00	-	110011
2"	121	170	2.62	42.00	-	110012
<b>American NPT taper thread (AT)</b>						
1/2"	57	95	0.38	2.00	2.30	110027
3/4"	65	100	0.54	5.00	5.90	110028
1"	78	114	0.84	10.00	11.70	110029
1 1/4"	89	138	1.36	16.00	18.70	110030
1 1/2"	100	159	1.76	23.00	26.90	110031
2"	121	170	2.62	42.00	49.10	110032
<b>ISO 228 (BS 2779) parallel thread (PT)</b>						
1/2"	57	95	0.38	2.00	-	110047
3/4"	65	100	0.54	5.00	-	110048
1"	78	114	0.84	10.00	-	110049
1 1/4"	89	138	1.36	16.00	-	110050
1 1/2"	100	159	1.76	23.00	-	110051
2"	121	170	2.62	42.00	-	110052

Temperature range: -10°C to +198°C

### 1031

#### Bronze globe valve

BS 5154 PN32 series B, metal disk, ISO 7 Rc taper thread

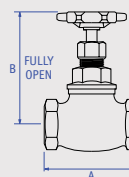

Valve Size	Dimensions in mm		Weight kg	Kv m <sup>3</sup> /h	Code
	A	B			
1/2"	57	95	0.39	2.30	112007
3/4"	65	100	0.55	5.90	112008
1"	78	114	0.87	11.70	112009
1 1/4"	89	138	1.45	18.70	112010
1 1/2"	100	159	1.83	26.90	112011
2"	121	170	2.61	49.10	112012
<b>ISO 228 (BS 2779) parallel thread (PT)</b>					
1/2"	57	95	0.39	2.30	112047
3/4"	65	100	0.55	5.90	112048
1"	78	114	0.87	11.70	112049
1 1/4"	89	138	1.45	18.70	112050
1 1/2"	100	159	1.83	26.90	112051
2"	121	170	2.61	49.10	112052

Temperature range: -10°C to +198°C

Kv = flow rate m<sup>3</sup> per hour at a pressure drop of 1 bar  
 Cv = flow rate in US GPM at a pressure drop of 1psi

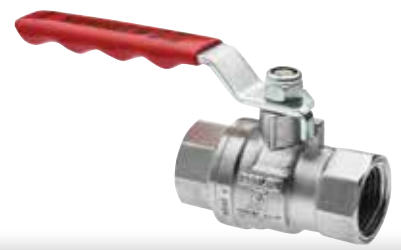

## BRONZE THREADED CHECK VALVES

### 1060A Bronze swing type check valve

BS 5154 PN25 series B, metal disk

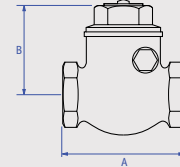

Valve Size	Dimensions in mm		Weight kg	Flow l/s	Kv m <sup>3</sup> /h	Cv-US GPM	Code
	A	B					
<b>ISO 7 Rc taper thread</b>							
1/2"	62	45	0.38	0.04	1.80	-	122007
				0.10	3.70	-	
				0.20	5.10	-	
				0.40	5.70	-	
3/4"	76	55	0.58	0.04	2.70	-	122008
				0.10	5.50	-	
				0.40	13.60	-	
				1.00	15.30	-	
1"	83	60	0.86	0.01	7.70	-	122009
				0.20	13.90	-	
				0.30	18.40	-	
				1.00	25.30	-	
1 1/4"	94	65	1.26	0.20	15.00	-	122010
				0.30	20.60	-	
				0.40	25.30	-	
				1.00	32.60	-	
1 1/2"	105	75	1.66	0.40	30.30	-	122011
				0.60	40.20	-	
				0.80	48.50	-	
				3.00	54.40	-	
2"	125	90	2.66	0.60	42.00	-	122012
				0.80	54.00	-	
				1.50	86.20	-	
				4.00	98.00	-	
2 1/2"	161	112	3.44	1.50	97.60	-	122013
				3.00	135.30	-	
				4.00	156.00	-	
3"	172	132	4.52	2.00	144.60	-	122014
				3.00	168.40	-	
				5.00	229.00	-	
				-	-	-	
4"	222	130	8.38	-	-	-	122015
<b>American NPT taper thread (AT)</b>							
1/2"	62	45	0.38	0.04	1.80	2.10	122027
				0.10	3.70	4.30	
				0.20	5.10	5.90	
				0.40	5.70	6.50	
3/4"	76	55	0.58	0.04	2.70	3.10	122028
				0.10	5.50	6.30	
				0.40	13.60	15.60	
				1.00	15.30	17.60	
1"	83	60	0.86	0.01	7.70	8.80	122029
				0.20	13.90	16.00	
				0.30	18.40	21.10	
				1.00	25.30	29.1	
1 1/4"	94	65	1.26	0.20	15.00	17.2	122030
				0.30	20.60	23.7	
				0.40	25.30	29.1	
				1.00	32.60	37.5	

Kv = flow rate m<sup>3</sup> per hour at a pressure drop of 1 bar  
Cv = flow rate in US GPM at a pressure drop of 1psi

### 1060A - Continued

2"	125	90	2.66	0.60	42.00	48.30	122032
				0.80	54.00	62.00	
				1.50	86.20	99.00	
				4.00	98.00	112.60	
2 1/2"	161	112	3.44	1.50	97.60	-	122033
				3.00	135.30	-	
				4.00	156.00	-	
3"	172	132	4.52	2.00	144.60	-	122034
				3.00	168.40	-	
				5.00	229.00	-	
<b>ISO 228 (BS 2779) parallel thread (PT)</b>							
1/2"	62	45	0.38	0.04	1.80	-	122047
				0.10	3.70	-	
				0.20	5.10	-	
				0.40	5.70	-	
3/4"	76	55	0.58	0.04	2.70	-	122048
				0.10	5.50	-	
				0.40	13.60	-	
1"	83	60	0.86	0.01	7.70	-	122049
				0.20	13.90	-	
				0.30	18.40	-	
				1.00	25.30	-	
1 1/4"	94	65	1.26	0.20	15.00	-	122050
				0.30	20.60	-	
				0.40	25.30	-	
1 1/2"	105	75	1.66	0.40	32.60	-	122051
				0.60	40.20	-	
				0.80	48.50	-	
				3.00	54.40	-	
2"	125	90	2.66	0.60	42.00	-	122052
				0.80	54.00	-	
				1.50	86.20	-	
				4.00	98.00	-	
2 1/2"	161	112	3.44	1.50	97.60	-	122053
3"	172	122	4.52	2.00	144.60	-	122054
4"	222	130	8.38	-	-	-	122055

Temperature range: -10°C to +186°C

### BRASS THREADED CHECK VALVES

#### 1062 Forged brass swing type check valve

BS 5154 PN25 Series B, metal disk, EN 10226 taper thread

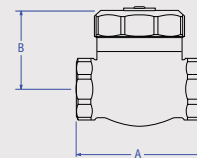

Valve Size	Dimensions in mm		Weight kg	Flow l/s	Kv m <sup>3</sup> /h	Code
	A	B				
<b>ISO 7 Rc taper thread</b>						
1/2"	58	34	0.27	0.04	1.80	124007
				0.10	3.70	
				0.20	5.10	
				0.40	5.70	
3/4"	72	40	0.48	0.04	2.70	124008
				0.10	5.50	

Temperature range: -10°C to +186°C

Kv = flow rate m<sup>3</sup> per hour at a pressure drop of 1 bar  
Cv = flow rate in US GPM at a pressure drop of 1psi

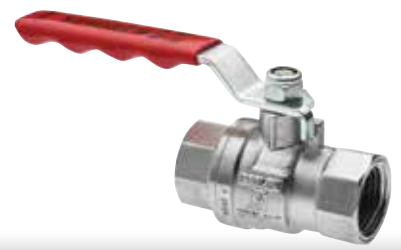

## 1062 - Continued

				0.40	13.60	
				1.00	15.30	
1"	83	51	0.72	0.01	7.70	124009
				0.20	13.90	
				0.30	18.40	
				1.00	25.30	
<b>ISO 228 (BS 2779) parallel thread (PT)</b>						
1/2"	58	34	0.27	0.04	1.80	124013
				0.10	3.70	
				0.20	5.10	
				0.40	5.70	
3/4"	72	40	0.48	0.04	2.70	124014
				0.10	5.50	
				0.40	13.60	
				1.00	15.30	
1"	83	51	0.72	0.01	7.70	124015
				0.20	13.90	
				0.30	18.40	
				1.00	25.30	

Temperature range: -10°C to +186°C

## 1063PT Forged brass spring check valve

3/8" to 1" 12bar, 1 1/4" to 2" 10bar, 2 1/2" to 4" 8bar  
ISO 228 (BS 2779) parallel thread (PT)

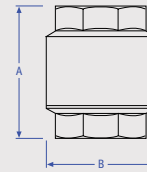

Valve Size	Dimensions in mm		Weight kg	Code
	A	B		
1/2"	49.5	34	0.12	124121
3/4"	57.5	41.5	0.23	124122
1"	61.5	47	0.25	124123
1 1/4"	66	58.5	0.39	124124
1 1/2"	76	69	0.58	124125
2"	87	84.5	0.85	124126
2 1/2"	100	103	1.38	124127
3"	110	112	1.97	124128
4"	114	145	2.83	124129

Temperature range: -10°C to +80°C

## 1064 Forged brass foot valve

3/8" to 1" 12bar, 1 1/4" to 2" 10bar, 2 1/2" to 4" 8bar

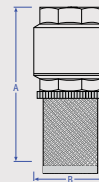

Valve Size	Dimensions in mm		Weight kg	Code
	A	B		
<b>ISO 228 (BS 2779) parallel thread (PT)</b>				
1/2"	83	34	0.13	124271
3/4"	96	41.5	0.20	124272
1/2"	83	34	0.13	124271
3/4"	96	41.5	0.20	124272
1"	107	47	0.27	124273

Kv = flow rate m<sup>3</sup> per hour at a pressure drop of 1 bar  
Cv = flow rate in US GPM at a pressure drop of 1psi

### 1064 - Continued

1 1/4"	120	58.5	0.41	124274
1 1/2"	136	69	0.62	124275
2"	159	84	0.91	124276
2 1/2"	181	103	1.46	124277
3"	201	112	2.07	124278
4"	217	145	3.01	124279
American NPT taper thread (AT)				
1/2"	83	34	0.13	124291
3/4"	96	41.5	0.20	124292
1"	107	47	0.27	124293
1 1/4"	120	58.5	0.41	124294
1 1/2"	136	69	0.62	124295
2"	159	84	0.91	124296

Temperature range: -10°C to +80°C

### BRASS THREADED CHECK VALVES

#### 2064PT Brass Foot Filter Valve

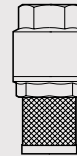

Valve Size	Dimensions in mm		Weight kg	Code
	A	B		
1/2" (PT)	78	34	0.08	124311
3/4" (PT)	89	41	0.13	124312
1" (PT)	100	46	0.17	124313
1 1/4" (PT)	112	58	0.28	124314
1 1/2" (PT)	129	68	0.44	124315
2" (PT)	150	84	0.60	124316
2 1/2" (PT)	171	102	1.12	124317
3" (PT)	188	111	1.59	124318
4" (PT)	205	144	2.49	124319
1/2" (AT)	78	34	0.08	124321
3/4" (AT)	89	41	0.13	124322
1" (AT)	100	46	0.17	124323
1 1/4" (AT)	112	58	0.28	124324
1 1/2" (AT)	129	68	0.44	124325
2" (AT)	150	84	0.60	124326

Temperature range: -10°C to +80°C

PT = ISO228 (BS2779) parallel thread. AT = American NPT taper thread

### BRONZE THREADED CHECK VALVES

#### 1039 Horizontal lift type check valve

BS 5154 PN32 series B, metal disk

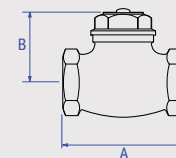

Valve Size	Dimensions in mm		Weight kg	Flow l/s	Kv m <sup>3</sup> /h	Code
	A	B				
EN 10226 taper thread						
1/2"	57	30	0.28	0.025	0.80	119007
				0.050	1.50	
				0.100	1.90	

Kv = flow rate m<sup>3</sup> per hour at a pressure drop of 1 bar



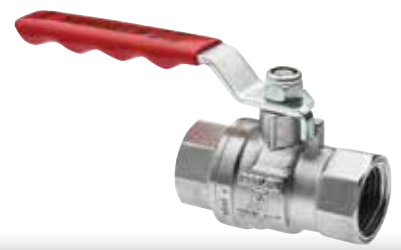

## 1039 - Continued

				0.200	2.60	
3/4"	65	40	0.44	0.075	2.40	119008
				0.100	2.90	
				0.150	3.40	
				0.200	3.50	
1"	78	45	0.68	0.050	1.90	119009
				0.100	3.60	
				0.200	6.30	
				0.400	8.50	
1 1/4"	89	55	1.14	0.060	2.20	119010
				0.080	2.90	
				0.200	6.80	
				0.600	13.90	
1 1/2"	100	60	1.46	0.100	3.90	119011
				0.300	10.70	
				0.500	16.80	
				0.700	21.40	
2"	121	65	2.24	0.200	6.90	119012
				0.400	13.40	
				0.800	25.40	
				1.400	39.70	
<b>ISO 228 (BS 2779) parallel thread (PT)</b>						
1/2"	57	30	0.28	0.025	0.80	119047
				0.050	1.50	
				0.100	1.90	
				0.200	2.60	
3/4"	65	40	0.44	0.075	2.40	119048
				0.100	2.90	
				0.150	3.40	
				0.200	3.50	
1"	78	45	0.68	0.050	1.90	119049
				0.100	3.60	
				0.200	6.30	
				0.400	8.50	
1 1/4"						119050
1 1/2"						119051
2"						119052

Temperature range: -10°C to +198°C

## BRASS THREADED CHECK VALVES

### Kuterlite K4426 Double check valve to EN 13959:2004 Type E D

ISO 228 parallel female ends

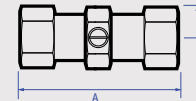

Valve Size	Dimensions in mm		Weight kg	Code
	A	B		
1/2"	70.5	25	0.15	42071
3/4"	82	31	0.24	42072
1"	106	38	0.42	42073
1 1/4"	122	46	0.61	42074
1 1/2"	135	52	0.85	42075
2"	199	66	1.66	42076

Temperature range: -10°C to +65°C

Kv = flow rate m<sup>3</sup> per hour at a pressure drop of 1 bar

### BRONZE THREADED STRAINERS

#### V913

#### Bronze strainer, Y pattern

Female x female, EN 10226 taper thread, PN16 Series B

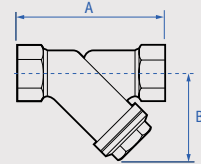

Valve Size	Dimensions in mm		Weight kg	Code
	A	B		
1/2"	63	40	0.23	15348
3/4"	67	48	0.32	15349
1"	80	60	0.45	15350
1 1/4"	114	70	0.74	15351
1 1/2"	120	82	0.92	15352
2"	137	73	1.06	15353
ISO 228 (BS 2779) parallel thread (PT)				
1/2"	63	40	0.23	119061
3/4"	67	48	0.32	119062
1"	80	60	0.45	119063
1 1/4"	114	70	0.74	119064
1 1/2"	120	82	0.92	119065
2"	137	73	1.06	119066

Temperature range: -10°C to +120°C

### BRASS THREADED STRAINERS

#### 1059PT

#### Brass Y type strainer, stainless steel mesh, PTFE gasket

Female parallel threads to ISO 228/1, PN20 rated to 2", PN16 above

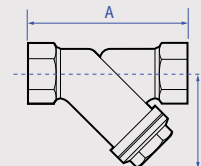

Valve Size	Dimensions in mm		Weight kg	Kv m <sup>3</sup> /h	Code
	A	B			
DN15	1/2"	58	40	0.140	120011
DN20	3/4"	70	48	0.200	120012
DN25	1"	87	56	0.380	120013
DN32	1 1/4"	96	64	0.560	120014
DN40	1 1/2"	106	73	0.800	120015
DN50	2"	126	89	1.100	120016
DN65	2 1/2"	150	107	1.950	120017
DN80	3"	169	120	3.050	120018
DN100	4"	219	161	5.650	120019

Temperature range: -10°C to +120°C

### THREADED DRAIN VALVES

#### PB60HU

#### DZR ball type drain valve

PN16, male x hose union inlet thread to ISO 228/1, 10bar 120°C

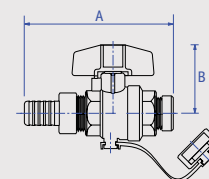

Valve Size	Dimensions in mm		Weight kg	Kv m <sup>3</sup> /h	Code
	A	B			
1/2"	95	45	0.25	17.00	254230
1"	130	59	0.63	70.00	254232

Temperature range: -10°C to +150°C

Kv = flow rate m<sup>3</sup> per hour at a pressure drop of 1 bar

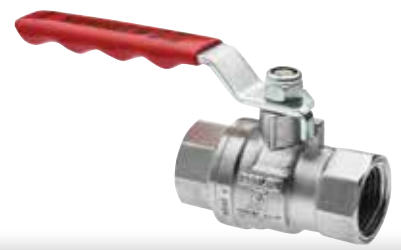

## BRONZE GLAND COCKS

**1832**

### Bronze gland cock

Male x hose union, 10bar 120°C, ISO 228 (BS 2779) parallel thread (PT). Supplied complete with malleable iron lever

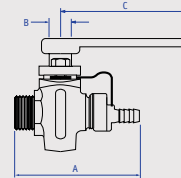

Valve Size	Dimensions in mm			Weight kg	Kv m <sup>3</sup> /h	Code
	A	B	C			
1/2"	93	10	86	0.44	17.00	130007
3/4"	117	13.5	95	0.76	41.00	130008
1"	145	15.9	121	1.32	70.00	130009

Temperature range: -10°C to +120°C

## BRASS THREADED PRESSURE REDUCING VALVES

**PRV4 PT**

### Brass nickel plate pressure reducing valves to EN 1567:2000

Female parallel threads to ISO 228/1. Max. inlet pressure 25bar, adjustable outlet pressure 0.5-6bar

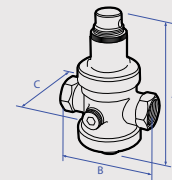

Valve Size	Connection Size	Dimensions in mm			Weight kg	Code
		A	B	C		
DN15	1/2"	118	77	66	0.71	5A2031
DN20	3/4"	141	91	73	1.12	5A2032
DN25	1"	152	91	75	1.33	5A2033
DN32	1 1/4"	217	116	94	2.29	5A2034
DN40	1 1/2"	218	125	95	2.42	5A2035
DN50	2"	244	142	114	3.62	5A2036
DN65	2 1/2"	264	147	114	4.00	5A2037
DN80	3"	287	148	114	5.53	5A2038
DN100	4"	325	188	125	6.80	5A2039

## AUTOMATIC AIR VENT

**P775**

### Brass automatic air vent

10bar at 120°C



Pattern No	Size	Dimensions in mm		Code
		A	B	
P775	1/2"	118	77	538009

Kv = flow rate m<sup>3</sup> per hour at a pressure drop of 1 bar

### WATER HAMMER ARRESTOR

#### PEG62 Water hammer arrestor, male thread

40bar maximum working temperature 90°C

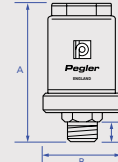

Valve Size	Dimensions in mm			Weight kg	Code
	A	B	C		
1/2"	52	90	12	0.5	5A2080

### BALL COMPRESSION GATE VALVES

#### 63 Brass full bore gate valve

Compression ends to EN 1254/2, PN16

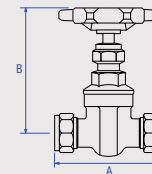

Valve Size	Dimensions in mm		Weight kg	Kv m <sup>3</sup> /h	Code
	A	B			
15mm	72	83	0.31	14.00	506007
22mm	81	93	0.47	32.00	506008
28mm	90	111	0.65	57.00	506009
35mm	107	124	1.26	90.00	506010
42mm	113	146	1.60	129.00	507011
54mm	129	174	2.70	230.00	507012

Temperature range: -10°C to +120°C

#### Prestex 63LS Brass full bore gate valve with lockshield

Compression ends to EN 1254/2, PN16

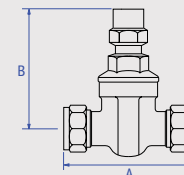

Valve Size	Dimensions in mm		Weight kg	Kv m <sup>3</sup> /h	Code
	A	B			
15mm	72	83	0.31	14.00	506037
22mm	81	93	0.47	32.00	506038
28mm	90	111	0.65	57.00	506039

Temperature range: -10°C to +120°C

#### Kuterlite K416 Brass full bore gate valve

Compression ends to EN 1254/2, PN16

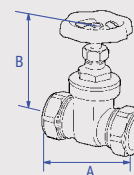

Valve Size	Dimensions in mm		Weight kg	Kv m <sup>3</sup> /h	Code
	A	B			
15mm	63	68	0.31	14.00	61689
22mm	74	77	0.42	32.00	61690
28mm	79	92	0.61	57.00	61691

Temperature range: -10°C to +110°C

Kv = flow rate m<sup>3</sup> per hour at a pressure drop of 1 bar



### Kuterlite K416LS Brass full bore gate valve with lockshield

Compression ends to EN 1254/2, PN16

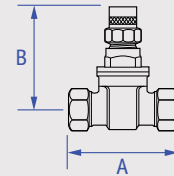

Valve Size	Dimensions in mm		Weight kg	Kv m <sup>3</sup> /h	Code
	A	B			
15mm	63	66	0.18	14.00	61695
22mm	74	72	0.37	32.00	61696
28mm	79	81	0.68	57.00	61697

Temperature range: -10°C to +110°C

### GUNMETAL COMPRESSION GATE VALVES

### Kuterlite K416GM Gunmetal full bore gate valve

Compression ends to EN 1254/2, PN16

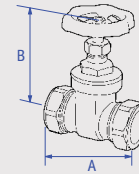

Valve Size	Dimensions in mm		Weight kg	Kv m <sup>3</sup> /h	Code
	A	B			
15mm	70	69	0.31	14.00	55985
22mm	80	80	0.42	32.00	55986
28mm	90	100	0.61	57.00	55987
35mm	113	113	1.02	90.00	55988
42mm	112	125	1.40	129.00	55989
54mm	134	150	2.43	230.00	55990

Temperature range: -10°C to +110°C. WRAS approval temperature 85°C.

### Kuterlite K416GMLS Gunmetal full bore gate valve with lockshield

Compression ends to EN 1254/2, PN16

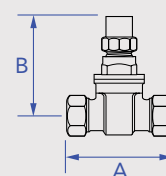

Valve Size	Dimensions in mm		Weight kg	Kv m <sup>3</sup> /h	Code
	A	B			
15mm	70	65	0.18	14.00	55991
22mm	80	75	0.37	32.00	55992
28mm	90	93	0.68	57.00	55993
35mm	113	110	1.14	90.00	55994
42mm	112	127	1.20	129.00	55995
54mm	134	147	2.61	230.00	55996

Temperature range: -10°C to +110°C. WRAS approval temperature 85°C.

Kv = flow rate m<sup>3</sup> per hour at a pressure drop of 1 bar

### Kuterlite K416GM Gunmetal full bore gate valve

Compression ends to EN 1254/2, PN16

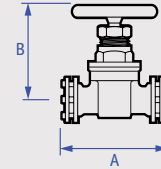

Valve Size	Dimensions in mm		Weight kg	Kv m <sup>3</sup> /h	Code
	A	B			
67mm	160	218	5.10	428.00	55997
76mm	183	248	5.98	680.00	55998

Temperature range: -10°C to +110°C

### CHROME PLATED COMPRESSION BALL VALVES

### PB300 Chrome plated brass full bore ball valve

Red lever handle, DZR body. Compression ends to EN 1254/2, PN16

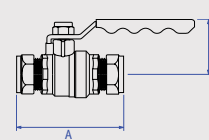

Valve Size	Dimensions in mm		Weight kg	Kv m <sup>3</sup> /h	Code
	A	B			
15mm	77	46	0.24	17.00	254001
22mm	85	54	0.41	41.00	254002
28mm	100	57	0.59	70.00	254003
35mm	120	62	0.88	121.00	254004
42mm	135	77	1.46	200.00	254005
54mm	160	84	2.35	292.00	254006

Temperature range: -10°C to +120°C Gas application: -20°C to +60°C maximum 5bar (MOP5)

\*Tested to EN 331:1998 + A1:2010  
Gas families 1,2,3

### PB300\* Chrome plated brass full bore ball valve

Yellow lever handle, compression ends to EN 1254/2, PN16

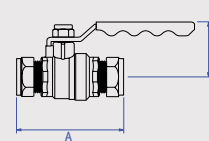

Valve Size	Dimensions in mm		Weight kg	Kv m <sup>3</sup> /h	Code
	A	B			
15mm	77	46	0.24	17.00	254011
22mm	85	54	0.41	41.00	254012
28mm	100	57	0.59	70.00	254013
35mm	120	62	0.88	121.00	254014
42mm	135	77	1.46	200.00	254015
54mm	160	84	2.35	292.00	254016

Temperature range: -10°C to +120°C Gas application: -20°C to +60°C maximum 5bar (MOP5)

\*Tested to EN 331:1998 + A1:2010  
Gas families 1,2,3

Kv = flow rate m<sup>3</sup> per hour at a pressure drop of 1 bar





### PB300 Chrome plated brass full bore ball valve

Blue lever handle, compression ends to EN 1254/2, PN16

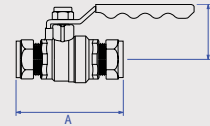

Valve Size	Dimensions in mm		Weight kg	Kv m <sup>3</sup> /h	Code
	A	B			
15mm	77	46	0.24	17.00	254021
22mm	85	54	0.41	41.00	254022
28mm	100	57	0.59	70.00	254023
35mm	120	62	0.88	121.00	254024
42mm	135	77	1.46	200.00	254025
54mm	160	84	2.35	292.00	254026

Temperature range: -10°C to +120°C Gas application: -20°C to +60°C maximum 5bar (MOP5)

\*Tested to EN 331:1998 + A1:2010 Gas families 1,2,3

### PB300T Chrome plated brass full bore ball valve

Red tee handle, DZR body. Compression ends to EN 1254/2, PN16

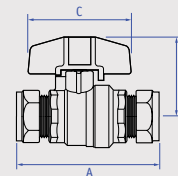

Valve Size	Dimensions in mm			Weight kg	Kv m <sup>3</sup> /h	Code
	A	B	C			
15mm	77	42	50	0.22	17.00	255001
22mm	85	54	60	0.39	41.00	255002
28mm	100	57	60	0.56	70.00	255003

Temperature range: -10°C to +120°C Gas application: -20°C to +60°C maximum 5bar (MOP5)

\*Tested to EN 331:1998 + A1:2010 Gas families 1,2,3

### PB300T Chrome plated brass full bore ball valve

Blue tee handle, compression ends to EN 1254/2, PN16

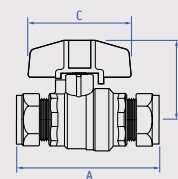

Valve Size	Dimensions in mm			Weight kg	Kv m <sup>3</sup> /h	Code
	A	B	C			
15mm	77	42	50	0.22	17.00	255011
22mm	85	54	60	0.39	41.00	255012
28mm	100	57	60	0.56	70.00	255013

Temperature range: -10°C to +120°C Gas application: -20°C to +60°C maximum 5bar (MOP5)

\*Tested to EN 331:1998 + A1:2010 Gas families 1,2,3

Kv = flow rate m<sup>3</sup> per hour at a pressure drop of 1 bar

### PB300T\* Chrome plated brass full bore ball valve

Yellow tee handle, compression ends to EN 1254/2, PN16

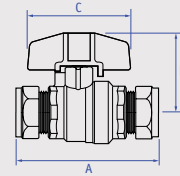

Valve Size	Dimensions in mm			Weight kg	Kv m <sup>3</sup> /h	Code
	A	B	C			
15mm	77	42	50	0.22	17.00	255021
22mm	85	54	60	0.39	41.00	255022
28mm	100	57	60	0.56	70.00	255023

Temperature range: -10°C to +120°C Gas application: -20°C to +60°C maximum 5bar (MOP5)

\*Tested to EN 331:1998 + A1:2010  
Gas families 1,2,3

### PB300 Chrome plated brass full bore ball valve

Green lever handle, compression ends to EN 1254/2, PN16

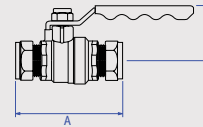

Valve Size	Dimensions in mm		Weight kg	Kv m <sup>3</sup> /h	Code
	A	B			
15mm	77	39	0.28	17.00	45001
22mm	85	50	0.48	41.00	45002
28mm	100	55	0.73	70.00	45003

Temperature range: -10°C to +120°C Gas application: -20°C to +60°C maximum 5bar (MOP5)

\*Tested to EN 331:1998 + A1:2010  
Gas families 1,2,3

### PB300T Chrome plated brass full bore ball valve

Green tee handle, compression ends to EN 1254/2, PN16

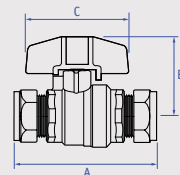

Valve Size	Dimensions in mm			Weight kg	Kv m <sup>3</sup> /h	Code
	A	B	C			
15mm	77	42	50	0.22	17.00	45013
22mm	85	54	60	0.39	41.00	45014

Temperature range: -10°C to +120°C Gas application: -20°C to +60°C maximum 5bar (MOP5)

\*Tested to EN 331:1998 + A1:2010  
Gas families 1,2,3

## DZR COMPRESSION BALL VALVES

### PB350 DZR lever ball valve

Blue lever handle, DZR body. Compression ends to EN 1254/2, PN16

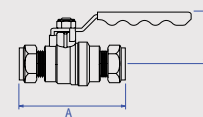

Valve Size	Dimensions in mm		Weight kg	Kv m <sup>3</sup> /h	Code
	A	B			
15mm	81	39	0.28	17.00	254201
22mm	90	54	0.45	41.00	254202
28mm	100	56	0.68	70.00	254203

Kv = flow rate m<sup>3</sup> per hour at a pressure drop of 1 bar



## PB350 - Continued

35mm	119	63	1.11	121.00	254204
42mm	133	78	1.61	200.00	254205
54mm	162	86	2.66	292.00	254206

Temperature range: -10°C to +120°C

## PB350LS DZR ball valve with lockshield

DZR body. Compression ends to EN 1254/2, PN16

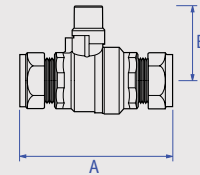

Valve Size	Dimensions in mm		Weight kg	Kv m <sup>3</sup> /h	Code
	A	B			
15mm	81	45	0.25	17.00	254220
22mm	90	54	0.41	41.00	254221
28mm	100	58	0.65	70.00	254222
35mm	119	65	1.06	121.00	254223
42mm	133	81	1.47	200.00	254224
54mm	162	89	3.06	292.00	254225

Temperature range: -10°C to +120°C

## PB350EL DZR ball valve with extended lever

DZR body. Compression ends to EN 1254/2, PN16

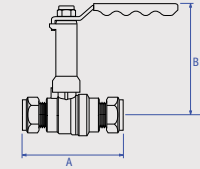

Valve Size	Dimensions in mm		Weight kg	Kv m <sup>3</sup> /h	Code
	A	B			
15mm	81	78	0.35	17.00	254243
22mm	90	97	0.54	41.00	254244
28mm	100	101	0.78	70.00	254245
35mm	119	108	1.20	121.00	254246
42mm	133	128	1.77	200.00	254247
54mm	162	146	2.90	292.00	254248

Temperature range: -10°C to +120°C

## DZR COMPRESSION CHECK VALVES

### Kuterlite K424 DZR single check valve to EN 13959:2004 Type E B

Compression ends, copper x copper

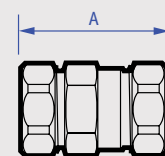

Valve Size	Dimensions in mm A	Weight kg	Code
15mm	58	0.11	42062
22mm	67	0.21	42063
28mm	87	0.37	42064

Kv = flow rate m<sup>3</sup> per hour at a pressure drop of 1 bar

### PB350T DZR ball valve

Blue tee handle, DZR body. Compression ends to EN 1254/2, PN16

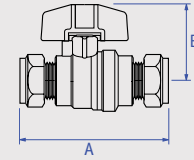

Valve Size	Dimensions in mm		Weight kg	Kv m <sup>3</sup> /h	Code
	A	B			
15mm	81	48	0.26	17.00	254211
22mm	90	60	0.42	41.00	254212
28mm	100	60	0.65	70.00	254213

Temperature range: -10°C to +120°C

### Kuterlite K424 DZR single check valve to EN 13959:2004 Type E D

Compression ends, copper x copper

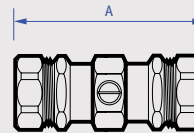

Valve Size	Dimensions in mm A	Weight kg	Code
15mm	83	0.17	42068
22mm	97	0.29	42069
28mm	109	0.47	42070

## DZR CHROME PLATED COMPRESSION CHECK VALVES

### Kuterlite K4424CP DZR chrome plated double check valve to EN 13595:2004 Type E D

Compression ends, copper x copper

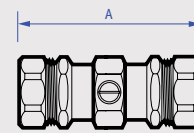

Valve Size	Dimensions in mm A	Weight kg	Code
15mm	83	0.17	42090

## DZR COMPRESSION ISOLATING BALL VALVES

### Ballofix minibore isolating ball valve – straight pattern

Compression ends. Screwdriver operation, raw finish

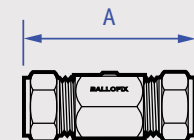

Connection Size	Pattern No.	Dimensions in mm A	Weight kg	Code
15mm	1581YA	41	0.11	13108

Kv = flow rate m<sup>3</sup> per hour at a pressure drop of 1 bar



## DZR CHROME PLATED COMPRESSION SERVICE VALVES

### Ballofix service valve – straight swivel pattern

Compression x BSP union nut. Screwdriver operation. Chrome plated

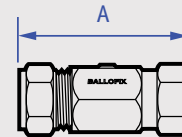

Connection Size	Pattern No.	Dimensions in mm A	Weight kg	Code
15mm x 1/2"	3140ZA	41	0.12	13133

### Ballofix service valve – straight swivel pattern

Compression x BSP union nut. Plastic lever operation. Chrome plated

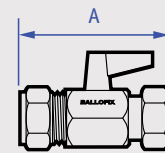

Connection Size	Pattern No.	Dimensions in mm A	Weight kg	Code
15mm x 1/2"	3140ZP	41	0.13	13135

### Ballofix service valve – angle swivel pattern

Compression x BSP union nut. Screwdriver operation. Chrome plated

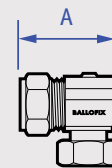

Connection Size	Pattern No.	Dimensions in mm A	Weight kg	Code
15mm	3160ZA	22	0.14	13143

## DZR CHROME PLATED COMPRESSION ISOLATING BALL VALVES

### Ballofix isolating ball valve – straight pattern

Compression x BSP parallel female thread. Plastic lever operation. DZR. Chrome plated

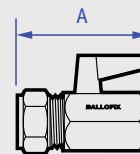

Connection Size	Pattern No.	Dimensions in mm A	Weight kg	Code
15mm	3331ZP	51	0.13	13236

## DZR CHROME PLATED COMPRESSION FILTER VALVES

### Ballofix filter valve

Compression ends. Screwdriver operation. Removable filter. Chrome plated

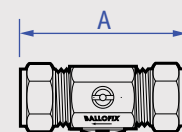

Connection Size	Pattern No.	Dimensions in mm A	Weight kg	Code
15mm	33615ZA	45	0.16	13304

Kv = flow rate m<sup>3</sup> per hour at a pressure drop of 1 bar

### DZR COMPRESSION ISOLATING BALL VALVES

#### Ballofix isolating ball valve – straight pattern

Compression x BSP parallel male thread. Screwdriver operation. DZR, raw finish

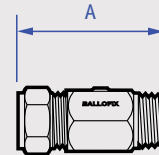

Connection Size	Pattern No.	Dimensions in mm A	Weight kg	Code
15mm	3375YA	40	0.13	13311

#### Ballofix isolating ball valve – angle pattern

Compression ends. Screwdriver operation. Raw finish

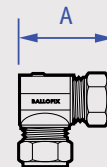

Connection Size	Pattern No.	Dimensions in mm A	Weight kg	Code
15mm	3380YA	20	0.12	13321

### DZR CHROME PLATED COMPRESSION ISOLATING BALL VALVES

#### Ballofix isolating ball valve – angle pattern

Compression ends. Screwdriver operation. Chrome plated

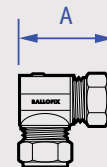

Connection Size	Pattern No.	Dimensions in mm A	Weight kg	Code
15mm	3380ZA	23	0.12	13324

#### Ballofix isolating ball valve – straight pattern

Compression ends. Screwdriver operation. Chrome plated

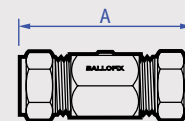

Connection Size	Pattern No.	Dimensions in mm A	Weight kg	Code
15mm	3381ZAF12	41	0.15	13339

### DZR COMPRESSION SERVICE VALVES

#### Ballofix service valve – angle swivel pattern

Compression x BSP union nut. Screwdriver operation. Raw finish

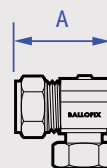

Connection Size	Pattern No.	Dimensions in mm A	Weight kg	Code
15mm	3160YA	22	0.14	13523



## DZR CHROME PLATED COMPRESSION ISOLATING BALL VALVES

### Ballofix isolating ball valve – straight pattern

Compression x BSP parallel female thread. Screwdriver operation. DZR. Chrome plated

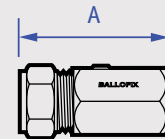

Connection Size	Pattern No.	Dimensions in mm A	Weight kg	Code
15mm	3331ZA	51	0.10	13531

## DZR COMPRESSION ISOLATING BALL VALVES

### Ballofix isolating ball valve – straight pattern

Compression ends. Screwdriver operation. DZR brass, raw finish

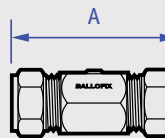

Connection Size	Pattern No.	Dimensions in mm A	Weight kg	Code
15mm	3381YA	41	0.14	13540
22mm	3481YA	57	0.22	13563
28mm	3581YA	65	0.54	13575

### Ballofix isolating ball valve – straight pattern

Compression ends. Plastic lever operation. DZR brass, raw finish

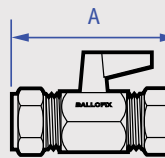

Connection Size	Pattern No.	Dimensions in mm A	Weight kg	Code
15mm	3381YP	41	0.17	13541

## DZR CHROME PLATED COMPRESSION ISOLATING BALL VALVES

### Ballofix isolating ball valve – straight pattern

Compression ends. Screwdriver operation. DZR brass, chrome plated

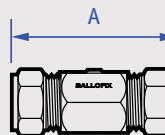

Connection Size	Pattern No.	Dimensions in mm A	Weight kg	Code
15mm	3381ZA	41	0.14	13543
22mm	3481ZA	57	0.22	13564
28mm	3581ZA	65	0.54	13576



### Ballofix isolating ball valve – straight pattern

Compression ends. Black plastic lever operation. Chrome plated

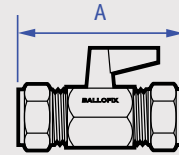

Connection Size	Pattern No.	Dimensions in mm A	Weight kg	Code
15mm	3381ZP	41	0.15	13544

### Ballofix isolating ball valve – straight pattern

Compression ends. Plastic CP lever operation. DZR brass, chrome plated

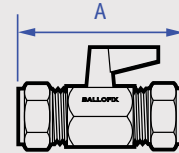

Connection Size	Pattern No.	Dimensions in mm A	Weight kg	Code
15mm	3381ZM	41	0.17	13545

## COMPRESSION SERVICE VALVES

### Ballofix service valve – straight swivel pattern

Compression x BSP union nut. Screwdriver operation. Raw finish

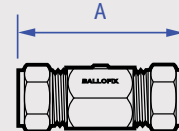

Connection Size	Pattern No.	Dimensions in mm A	Weight kg	Code
15mm x 1/2"	3140YA	41	0.12	13658

## BALLOFIX ACCESSORIES

### Small plastic handle – with hexagon spigot



Pattern No.	Colour	Code
CPT0059	Black	13712

### Large plastic handle – with hexagon spigot



Pattern No.	Colour	Code
CPT0073	Black	13721

### Small plastic handle – with screw



Pattern No.	Colour	Code
ERG	Black	13724
ERG	Red	13728
ERG	Blue	13729
ERG	Chrome	13732

### Large plastic handle – with screw



Pattern No.	Colour	Code
ERG	Black	13725

### Flow regulator insert

To maintain a defined flow rate



Pattern No.	Flow Rate	Colour	Code
15mm	4 l/m	Pink	13779
15mm	6 l/m	Grey	13780
15mm	8 l/m	White	13781
15mm	9/10 l/m	Yellow	13782
15mm	12 l/m	Brown	13783
22mm	12 l/m	Orange	13784
22mm	18 l/m	Brown	13785

### BALL VALVE ACCESSORIES\*

#### Locking device\*

For standard lever handle products.  
PB700, PB500, PB550 series only

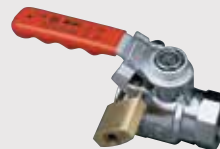

Pattern No.	Suitable For	Code
LD1	1/4", 3/8", 1/2"	258001
LD2	3/4", 1", 1 1/4"	258002
LD3	1 1/2", 2"	258003

\*Not suitable for PB300, PB100 and PB50 series valves

### Padlock and key



Pattern No.	Suitable For	Code
PDK3	1/4", 3/8", 1/2", 3/4", 1", 1 1/4"	258011
PDK4	1 1/2", 2"	258012

### PBSEK Stem extension kits

Suitable for PB700/PB500 ranges



Pattern No.	Suitable For	Code
PBSEK7	1/4", 3/8", 1/2", 15mm	227027
PBSEK8	3/4", 1", 1 1/4", 22mm, 28mm, 35mm	227028
PBSEK9	1 1/2", 2", 42mm, 54mm	227029
PBSEK10	2 1/2"	227030
PBSEK11	3", 4"	227031

\*Not suitable for PB300 and PB100 ranges

### Lockshield key

Suitable for PB350/550 DR LS



Pattern No.	Suitable For	Weight kg	Code
PB LS cross key	1/2" - 1 1/4" 15mm - 35mm	0.11	227040
PB LS cross key	1 1/2" - 2" 42mm - 54mm	0.38	227041

# IN-LINE THERMOSTATIC MIXING VALVES



## CHROME PLATED IN-LINE THERMOSTATIC MIXING VALVES

### PEG402 TMV3/2 Valve

All ends compression. Copper x copper

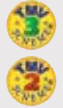
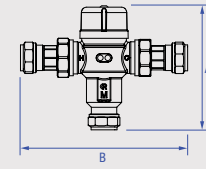

Valve Size	Dimensions in mm		Code
	A	B	
15mm	102	137	5A1401
22mm	103	156	5A1402

### PEG402UA TMV3/2 Valve

All ends compression. Copper x copper. With angle valves

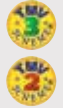
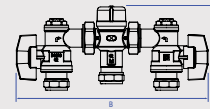

Valve Size	Dimensions in mm		Code
	A	B	
15mm	102	212	5A1403
22mm	103	240	5A1404

### PEG402UAX TMV3/2 Valve

All ends compression. Copper x copper. With angle valves and connection to cold outlet

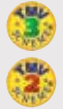
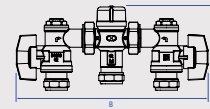

Valve Size	Dimensions in mm		Code
	A	B	
15mm	102	212	5A1405
22mm	103	240	5A1406

### CAST IRON FLANGED GATE VALVES

#### V950 Ductile iron gate valve PN16

BS EN 1171:2002 PN16, 16bar from -10°C to 120°C,  
11.8bar 230°C

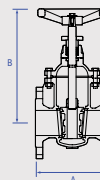

Valve Size	Dimensions in mm		Weight kg	Kv m <sup>3</sup> /h	Code
	A	B			
DN50	178	240	12.0	230.00	15510
DN65	191	265	16.9	360.00	15511
DN80	203	323	19.1	519.00	15512
DN100	229	365	26.6	923.00	15513
DN125	254	413	37.9	1443.00	15514
DN150	267	477	47.4	2077.00	15515
DN200	292	585	73.9	3693.00	15516
DN250	330	710	122.0	5771.00	15517
DN300	356	789	171.0	8310.00	15518

#### V951 Cast iron gate valve PN6

BS EN 1171:2002 PN6, 6bar from -10°C to 120°C, 5.4bar  
150°C

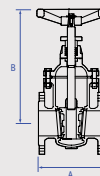

Valve Size	Dimensions in mm		Weight kg	Kv m <sup>3</sup> /h	Code
	A	B			
DN65	159	244	18.5	360.00	15520
DN80	165	265	24.1	923.00	15521
DN100	171	275	28.8	519.00	15522
DN125	190	334	50.0	1443.00	15523
DN150	210	358	62.0	2077.00	15524
DN200	241	418	85.5	3693.00	15525

### CAST IRON FLANGED BUTTERFLY VALVES

#### V905 Cast iron butterfly valve

Fully lugged, to BS EN 593:2004, face to face dimensions  
to BS EN 558:2008

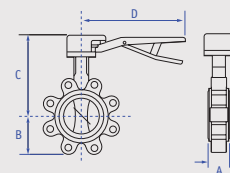

Valve Size	Dimensions in mm				Weight kg	Kv m <sup>3</sup> /h	Code
	A	B	C	D			
DN65	46	70	181	200	5.80	229.32	15300
DN80	46	89	187	200	6.00	353.34	15301
DN100	52	106	211	290	10.30	702.00	15302
DN125	56	120	226	290	13.50	1195.74	15303
DN150	56	132	239	290	14.60	1847.43	15304
DN200	60	164	293	450	21.40	3669.12	15305

Kv = flow rate m<sup>3</sup> per hour at a pressure drop of 1 bar



## V905G Cast iron butterfly valve geared

Fully lugged, to BS EN 593:2004, face to face dimensions to BS EN 558:2008

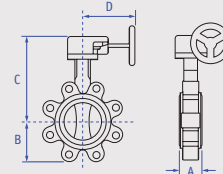

Valve Size	Dimensions in mm				Weight kg	Kv m <sup>3</sup> /h	Code
	A	B	C	D			
DN250	68	200	469	341	42.00	6247.80	15306
DN300	78	238	494	341	67.00	9652.50	15307

## V906 Cast iron butterfly valve

Semi lugged, to BS EN 593:2004, face to face dimensions to BS EN 558:2008

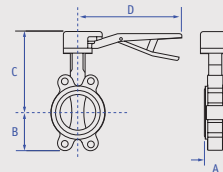

Valve Size	Dimensions in mm				Weight kg	Kv m <sup>3</sup> /h	Code
	A	B	C	D			
DN65	46	70	181	200	4.40	229.32	15316
DN80	46	89	187	200	5.00	353.34	15317
DN100	52	106	211	290	6.10	702.00	15318
DN125	56	120	226	290	8.00	1195.74	15319
DN150	56	132	239	290	9.60	1847.43	15320
DN200	60	164	293	450	15.10	3669.12	15321

## V906G Cast iron butterfly valve geared

Semi lugged, to BS EN 593:2004, face to face dimensions to BS EN 558:2008

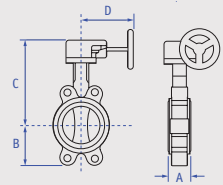

Valve Size	Dimensions in mm				Weight kg	Kv m <sup>3</sup> /h	Code
	A	B	C	D			
DN250	68	200	469	341	31.50	6247.80	15322
DN300	78	238	494	341	50.50	9652.50	15323

## V907 Cast iron butterfly valve for gas applications

Fully lugged pattern PN6, 6bar from 5°C to 85°C.  
Nitrile lining

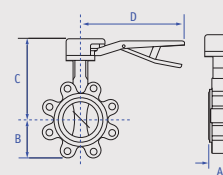

Valve Size	Dimensions in mm				Weight kg	Kv m <sup>3</sup> /h	Code
	A	B	C	D			
DN65	46	70	181	200	5.00	229.32	15332
DN80	46	89	187	200	5.50	353.34	15333
DN100	52	106	211	290	8.40	702.00	15334
DN125	56	120	226	290	9.80	1195.74	15335
DN150	56	132	239	290	11.80	1847.43	15336
DN200	60	164	293	450	23.00	3669.12	15337

Kv = flow rate m<sup>3</sup> per hour at a pressure drop of 1 bar

### V907G Cast iron butterfly valve geared

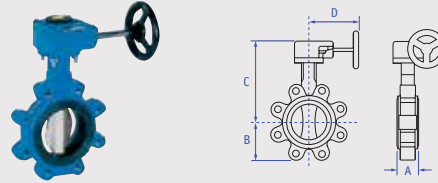

Valve Size	Dimensions in mm				Weight kg	Kv m <sup>3</sup> /h	Code
	A	B	C	D			
DN250	68	200	469	341	35.80	6247.80	15338
DN300	78	238	494	341	49.80	9652.50	15339

### BALLOMAX STEEL FLANGED ISOLATING BALL VALVES

#### PB1006 Ballomax steel ball valve Flanged PN16

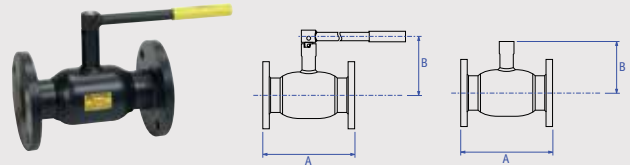

Valve Size	Dimensions in mm		Weight kg	Kv m <sup>3</sup> /h	Code
	A	B			
<b>DN65 - DN100 lever operated</b>					
DN65 64103065	270	144	9.90	160.00	13972
DN80 64103080	280	154	13.20	280.00	13973
DN100 64103100	300	193	18.30	450.00	13974
<b>DN125 - DN500 without lever</b>					
DN125 64103125	325	221	25.10	690.00	13885
DN150 64103150	350	245	38.20	1100.00	13886
DN200 64103200	400	289	61.70	1500.00	13887
DN250 64103250	650	306	140.00	2770.00	13888
DN300 64103300	750	336	225.00	4620.00	13860
DN350 64103350	850	395	300.00	7250.00	13861
DN400 64103400	950	445	450.00	10540.00	13862
DN500 64103500	1150	522	705.00	11780.00	13863

#### PB1005 Ballomax steel ball valve Flanged PN40, lever operated

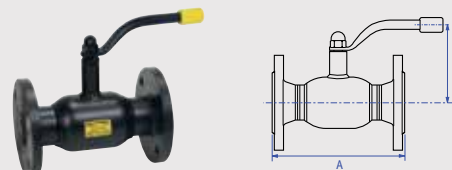

Valve Size	Dimensions in mm		Weight kg	Kv m <sup>3</sup> /h	Code
	A	B			
DN15 64103015	130	116	1.50	6.00	13984
DN20 64103020	150	85	2.90	14.00	13985
DN25 64103025	160	89	3.50	26.00	13986
DN32 64103032	180	93	4.80	43.00	13987
DN40 64103040	200	108	6.20	64.00	13988
DN50 64103050	230	114	8.20	100.00	13971

Kv = flow rate m<sup>3</sup> per hour at a pressure drop of 1 bar





## DUCTILE IRON FLANGED STRAINERS

### V912 Ductile iron Y type strainer

PN16, -10°C to 120°C 13bar at 220°C. Raised flanges in accordance with BS EN 1092-2:1997 PN16

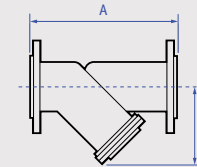

Valve Size	Dimensions in mm		Weight kg	Mesh Diameter	Kv m <sup>3</sup> /h	Code
	A	B				
DN65	290	180	14.30	1.5mm	93	15361
DN80	310	215	18.0	1.5mm	136	15362
DN100	350	235	25.0	1.5mm	229	15363
DN125	400	275	40.0	1.5mm	363	15364
DN150	480	305	54.0	1.5mm	499	15365
DN200	600	390	108.0	2.5mm	817	15366
DN250	730	540	180.0	2.5mm	1361	15367
DN300	850	680	330.0	2.5mm	1928	15368

## CAST IRON FLANGED CHECK VALVES

### V909 Cast iron wafer pattern check valve

Wafer dual plate check valve, 16bar from -10°C to 110°C. BS EN 12334:2001 and face to face dimensions comply to BS EN 558-1

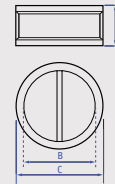

Valve Size	Dimensions in mm			Weight kg	Flow l/H	Kv m <sup>3</sup> /h	Code
	A	B	C				
DN65	46	78	126	2.3	1.50	57.00	15398
					2.50	81.00	
					6.00	126.00	
					10.00	139.00	
DN80	64	90	141	3.7	1.50	55.00	15399
					2.50	85.00	
					6.00	140.00	
					10.00	167.00	
DN100	64	115	161	4.2	2.50	101.00	15400
					8.00	200.00	
					15.00	243.00	
					25.00	259.00	
DN125	70	141	191	6.3	4.00	135.00	15401
					6.00	190.00	
					15.00	336.00	
					30.00	413.00	
DN150	76	170	217	9.2	6.00	216.00	15402
					10.00	338.00	
					20.00	556.00	
					40.00	747.00	
DN200	89	210	272	14.8	10.00	423.00	15403
					20.00	797.00	
					40.00	1340.00	
					80.00	1770.00	
DN250	114	273	327	25.5	160.00	2600.00	15404
DN300	114	324	382	40.7	220.00	4300.00	15405

Kv = flow rate m<sup>3</sup> per hour at a pressure drop of 1 bar

### V909 Kv values

Valve sizing coefficients (m<sup>3</sup>@1Δp)

Valve Size	10°	20°	30°	40°	50°	60°	70°	80°	90°
DN65 2 1/2"	0.08569	5.141388	10.28278	21.42245	38.56041	64.26735	101.9709	152.5278	167.952
DN80 3"	0.17138	7.712082	15.42416	33.41902	59.98286	99.40017	156.8123	235.647	258.7832
DN100 4"	0.257069	14.56727	30.84833	66.83805	119.1088	197.0865	311.9109	467.8663	514.1388
DN125 5"	0.428449	24.85004	52.27078	113.9674	203.0848	335.904	531.2768	796.9152	875.7498
DN150 6"	0.685518	38.56041	81.40531	175.6641	313.6247	518.4233	820.9083	1231.362	1353.042
DN200 8"	1.713796	76.26392	161.0968	349.6144	622.9649	1029.991	1630.677	2445.587	2687.232
DN250 10"	2.570694	129.3916	274.2074	594.6872	1059.983	1754.07	2776.35	4163.668	4575.835
DN300 12"	3.427592	200.5141	424.1654	918.5947	1637.532	2709.512	4288.775	6432.734	7069.409

### V909 Cv values

Valve sizing coefficients (US-GPM@1Δp)

Valve Size	10°	20°	30°	40°	50°	60°	70°	80°	90°
DN65 2 1/2"	0.10	6.00	12.00	25.00	45.00	75.00	119.00	178.00	196.00
DN80 3"	0.20	9.00	18.00	39.00	70.00	116.00	183.00	275.00	302.00
DN100 4"	0.30	17.00	36.00	78.00	139.00	230.00	364.00	546.00	600.00
DN125 5"	0.50	29.00	61.00	133.00	237.00	392.00	620.00	930.00	1022.00
DN150 6"	0.80	45.00	95.00	205.00	366.00	605.00	958.00	1437.00	1579.00
DN200 8"	2.00	89.00	188.00	408.00	727.00	1202.00	1903.00	2854.00	3136.00
DN250 10"	3.00	151.00	320.00	694.00	1237.00	2047.00	3240.00	4859.00	5340.00
DN300 12"	4.00	234.00	495.00	1072.00	1911.00	3162.00	5005.00	7507.00	8250.00



## CAST IRON FLANGED SWING CHECK VALVES

### V914

#### Cast iron swing check valve

BS EN 12334:2001 PN16, 16bar from -10°C to 120°C,  
11.8bar 230°C

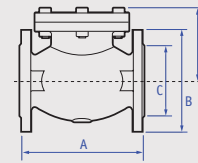

Valve Size	Dimensions in mm				Weight kg	Flow l/s	Kv m <sup>3</sup> /h	Code
	A	B	C	D				
DN65	216	132	122	132.5	17.5	1.50	63.00	15378
						5.00	150.00	
						8.00	161.00	
DN80	241	141	138	141.5	21.4	2.00	75.00	15379
						6.00	202.00	
						12.00	328.00	
						20.00	428.00	
DN100	292	162	158	163.0	37.0	4.00	168.00	15380
						10.00	353.00	
						15.00	447.00	
						20.00	516.00	
DN125	330	192	188	197.0	56.2	5.00	173.00	15381
						10.00	361.00	
						20.00	602.00	
						30.00	689.00	
DN150	356	211	212	212.0	72.4	7.00	298.00	15382
						20.00	735.00	
						40.00	1231.00	
DN200	495	270	268	257.0	122.7	15.00	520.00	15383
						40.00	1210.00	
						90.00	1835.00	
DN250	622	316	320	298.5	198.0	Fully open	2725.00	15384
DN300	699	357	378	330.5	292.0	Fully open	3850.00	15385

Kv = flow rate m<sup>3</sup> per hour at a pressure drop of 1 bar

### BALLOMAX STEEL WELD BALL VALVES

#### PB1002

#### Ballomax steel ball valve

Weld x weld, standard PN40, lever operated

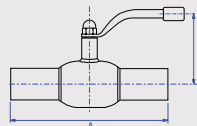

Valve Size	Dimensions in mm		Weight kg	Kv m <sup>3</sup> /h	Code
	A	B			
1/2" x 1/2" 61102015	210	116	0.80	6.00	13664
3/4" x 3/4" 64102020	230	115	0.80	14.00	13665
1" x 1" 64102025	230	120	1.00	26.00	13666
1 1/4" x 1 1/4" 64102032	260	124	1.40	43.00	13667
1 1/2" x 1 1/2" 64102040	260	129	2.10	64.00	13668
2" x 2" 64102050	300	135	3.00	100.00	13977

#### PB1004

#### Ballomax steel ball valve

Weld x weld, standard PN25, no lever

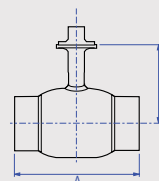

Valve Size	Dimensions in mm		Weight kg	Kv m <sup>3</sup> /h	Code
	A	B			
5" x 5" 61102125 Lever	390	221	17.30	690.00	13981
6" x 6" 61102150 GB	390	245	26.90	1100.00	13982
8" x 8" 61102200 GB	390	289	43.30	1500.00	13983
10" x 10" 61102250 GB	630	306	115.00	2770.00	13936
12" x 12" 61102300 GB	710	336	195.00	4620.00	13937
14" x 14" 61102350 GB	750	395	235.00	7250.00	13938
16" x 16" 61102400 GB	860	445	390.00	10540.00	13939
20" x 20" 61102500 GB	970	522	610.00	11780.00	13940

#### PB1003

#### Ballomax steel ball valve

Weld x weld, standard PN25, lever operated

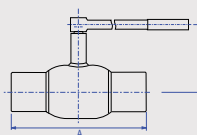

Valve Size	Dimensions in mm		Weight kg	Kv m <sup>3</sup> /h	Code
	A	B			
2 1/2" x 2 1/2" 64102065	360	144	4.50	160.00	13978
3" x 3" 64102080	370	154	6.00	280.00	13979
4" x 4" 64102100	390	193	9.70	450.00	13980

Kv = flow rate m<sup>3</sup> per hour at a pressure drop of 1 bar



**PB1007**  
**Ballomax pre-insulated steel ball valve**  
**with 2 service valves**

Weld x weld. PN25



Valve Size	Dimensions in mm		Weight kg	Code
	A	B		
DN40	1510	407	23	14040
DN50	1510	414	27	14041
DN65	1510	423	30	14042
DN80	1510	433	36	14043
DN100	1510	451	51	14044
DN125	1510	492	63	14045
DN150	1510	513	89	14046
DN200	1510	562	128	14047
DN250	1510	613	208	14048

**BALLOMAX ACCESSORIES**

**Hot tapping tool kit with case**

Standard PN25



Size	Code
DN15 - 50mm 68500015	14007



## 3.0 TECHNICAL DATA

# PRESSURE AND TEMPERATURE RATINGS

### CONVERSION FORMULAS

#### TEMPERATURE:

Celsius to Fahrenheit      Fahrenheit to Celsius  
 $^{\circ}\text{F} = \frac{(9 \times ^{\circ}\text{C})}{5} + 32$        $^{\circ}\text{C} = x5 \frac{(^{\circ}\text{F} - 32)}{9}$

#### PRESSURE:

Bar to psi      psi to bar  
 $\times 14.5038$        $\div 14.5038$

### PUSH-FIT VALVES

#### ALL PUSH-FIT VALVES

Product	Size	Max. working pressure (bar)				Max. working pressure (psi)				Test pressure (bar) (psi)			
		Temp	bar	Temp	bar	Temp	psi	Temp	psi	Shell	Seat	Shell	Seat
Push-fit valves	DN15 to DN50	30°C max	16	up to 95°C	6	up to 86°F	232.1	up to 230°F	87	24	17.6	348	255.3

### XT PRESS-FIT X PUSH-FIT VALVES

#### ALL XT PRESS-FIT X PUSH-FIT VALVES

Product	Size	Max. working pressure (bar)				Max. working pressure (psi)				Test pressure (bar) (psi)			
		Temp	bar	Temp	bar	Temp	psi	Temp	psi	Shell	Seat	Shell	Seat
Press-fit x push-fit valves	DN15 to DN50	30°C max	16	up to 95°C	6	up to 86°F	232.1	up to 230°F	87	24	17.6	348	255.3

### PRESS-FIT VALVES

#### ALL PRESS FIT VALVES

Product	Size	Max. working pressure (bar)				Max. working pressure (psi)				Test pressure (bar) (psi)			
		Temp	bar	Temp	bar	Temp	psi	Temp	psi	Shell	Seat	Shell	Seat
1070/125/1068/1078	DN15 to DN54	30°C max	16	up to 110°C	16	up to 86°F	232.1	up to 230°F	232.1	24	17.6	348	255.3
PRV	DN15 to DN54			up to 80°C									

### HENCO MULTI-LAYER PRESS-FIT VALVES

#### ALL HENCO MULTI-LAYER PRESS-FIT VALVES

Product	Size	Max. working pressure (bar)				Max. working pressure (psi)				Test pressure (bar) (psi)			
		Temp	bar	Temp	bar	Temp	psi	Temp	psi	Shell	Seat	Shell	Seat
Press-fit valves	DN15 to DN32	95°C max	10	up to 95°C	10	up to 203°F	155	up to 203°F	155	15	11	218	160

### THREADED VALVES

#### THREADED VALVES

Product	Size	Max. working pressure (bar)				Max. working pressure (psi)				Test pressure (bar) (psi)			
		Temp	bar	Temp	bar	Temp	psi	Temp	psi	Shell	Seat	Shell	Seat
PB700, PB700T	1/4" to 2"	up to 100°C	40	up to 186°C	10	212°F	580.2	389°F	145	60	44	870.2	638.2
PB500, PB500T, PB500EL	1/4" to 4"	up to 100°C	25	up to 150°C	16.5	212°F	362.6	302°F	293.3	37.5	27.5	543.9	398.9
PB550DR, PB550DRT, PB550LS, PB550EL	1/2" to 2"	up to 100°C	25	up to 150°C	16.5	212°F	362.6	302°F	293.3	37.5	27.5	543.9	398.9
PB100	1/2" to 2"	up to 20°C	25	up to 120°C	4	up to 68°F	362.6	up to 248°F	58	37.5	27.5	543.9	398.9
PB100	2 1/2" to 4"	up to 20°C	16	up to 120°C	4	up to 68°F	232.1	up to 248°F	58	24	17.5	348.1	253.8



**BIBTAPS AND VENT VALVES**

Product	Size	Max. working pressure (bar)				Max. working pressure (psi)				Test pressure (bar) (psi)			
		Temp	bar	Temp	bar	Temp	psi	Temp	psi	Shell	Seat	Shell	Seat
PB50HU, PB50, PB50AT, PB52HU	1/2" to 3/4"	up to 60°C	16	up to 100°C	8	up to 140°F	232.1	212°F	116	24	14.6	348.1	253.8
1111BV	1" to 2"	up to 80°C	25	up to 150°C	5	176°F	362.6	302°F	72.5	37.5	27.5	543.9	398.9

**COMBI BALL VALVES AND STRAINERS**

Product	Size	Max. working pressure (bar)				Max. working pressure (psi)				Test pressure (bar) (psi)			
		Temp	bar	Temp	bar	Temp	psi	Temp	psi	Shell	Seat	Shell	Seat
PB560, PB560EXT	3/4"	up to 30°C	20	up to 114°C	10	up to 86°F	290.1	up to 237°F	145	30	22	435.1	319.1

**BALLOMAX STEEL BALL VALVES**

Product	Size	Max. working pressure (bar)				Max. working pressure (psi)				Test pressure (bar) (psi)			
		Temp	bar	Temp	bar	Temp	psi	Temp	psi	Shell	Seat	Shell	Seat
PB1000, PB1001	1/2" to 2"	up to 100°C	40	up to 165°C	16	212°F	580.2	329°F	232.1	60	44	870.2	638.2

**BALLOFIX ISOLATING BALL VALVES**

Product	Size	Max. working pressure (bar)				Max. working pressure (psi)				Test pressure (bar) (psi)			
		Temp	bar	Temp	bar	Temp	psi	Temp	psi	Shell	Seat	Shell	Seat
Ballofix	1/4" to 1" for water services	max 120°C	16	max 120°C	16	max 248°F	232.1	max 248°F	232.1	24	17.6	348.1	253.8
Ballofix	1/2" for gas services	max 60°C	4	max 60°C	4	max 140°F	58	max 140°F	58	6	4.4	87	63.8

**GATE VALVES**

Product	Size	Max. working pressure (bar)				Max. working pressure (psi)				Test pressure (bar) (psi)			
		Temp	bar	Temp	bar	Temp	psi	Temp	psi	Shell	Seat	Shell	Seat
1072	1/2" to 2"	up to 100°C	32	up to 198°C	14.5	up to 212°F	464.1	up to 389°F	210.3	48	35.2	696.2	510.5
1070/125, 1070/125LS	1/4" to 4"	up to 100°C	20	up to 180°C	9	212°F	290.1	356°F	130.5	30	22	435.1	319.1
1065	1/2" to 2"	up to 25°C	17.5	up to 93°C	17.5	up to 77°F	253.8	up to 200°F	253.8	26.3	19.3	381.5	279.5
1068,1068LS	1/2" to 4"	up to 100°C	20	up to 180°C	9	212°F	290.1	356°F	130.5	30	22	435.1	319.1
1078,1078LS	1/2" to 2"	up to 100°C	20	up to 180°C	9	212°F	290.1	356°F	130.5	30	22	435.1	319.1

**GLOBE VALVES**

Product	Size	Max. working pressure (bar)				Max. working pressure (psi)				Test pressure (bar) (psi)			
		Temp	bar	Temp	bar	Temp	psi	Temp	psi	Shell	Seat	Shell	Seat
1029	1/4" to 2"	up to 100°C	32	up to 198°C	14	up to 86°F	464.1	up to 248°F	203.1	48	35.2	696.1	510.5
1031	1/2" to 2"	up to 100°C	32	up to 198°C	14	212°F	464.1	up to 389°F	203.1	48	35.2	696.2	510.5





## 3.0 TECHNICAL DATA

# PRESSURE AND TEMPERATURE RATINGS

### THREADED VALVES - CONTINUED

CHECK VALVES													
Product	Size	Max. working pressure (bar)				Max. working pressure (psi)				Test pressure (bar) (psi)			
		Temp	bar	Temp	bar	Temp	psi	Temp	psi	Shell	Seat	Shell	Seat
1060A	1/2" to 2"	up to 100°C	25	up to 186°C	10.5	up to 112°F	362.6	up to 376°F	152.3	37.5	27.5	543.9	398.9
1060A	2 1/2" to 4"	up to 110°C	16	up to 140°C	10	up to 230°F	232.1	up to 284°F	154	24	17.5	348.1	253.8
1062	1/2" to 1"	up to 100°C	25	up to 186°C	10.5	212°F	362.6	up to 389°F	152.3	37.5	27.5	543.9	398.9
1063, 1064, 2064	1/2" to 3/4"	max 90°C	12			max 194°F	174			18	13.2	261.1	191.4
1063, 1064, 2064	1" to 2"	max 90°C	10			max 194°F	145			15	11	217.6	159.5
1063, 1064, 2064	2 1/2" to 4"	max 90°C	8			max 194°F	116			12	8.8	174	127.6
1039	1/2" to 1"	up to 100°C	32	up to 198°C	14	212°F	290.1	up to 389°F	203.1	48	35.2	696.2	510.5
K4426	1/2" to 2"	up to 95°C	16			up to 203°F	232.1			24	17.6	348.1	253.8
2064PT	1/2" to 3/4"	up to 100°C	12			max 212°F	174			18	13.2	261.1	191.4
1063, 1064, 2064	1" to 2"	up to 100°C	10			max 212°F	145			15	11	217.6	159.5
1063, 1064, 2064	2 1/2" to 4"	up to 100°C	8			max 212°F	116			12	8.8	174	127.6

STRAINERS													
Product	Size	Max. working pressure (bar)				Max. working pressure (psi)				Test pressure (bar) (psi)			
		Temp	bar	Temp	bar	Temp	psi	Temp	psi	Shell	Seat	Shell	Seat
V913	1/2" to 2"	up to 100°C	25	up to 186°C	10.5	212°F	362.6	up to 389°F	152.3	37.5	27.5	543.9	398.9
1059PT	1/2" to 2"	up to 100°C	20			212°F	290.1			30	22	435.1	319.1

MISCELLANEOUS													
Product	Size	Max. working pressure (bar)				Max. working pressure (psi)				Test pressure (bar) (psi)			
		Temp	bar	Temp	bar	Temp	psi	Temp	psi	Shell	Seat	Shell	Seat
PB60HU	1/2" to 1"	up to 30°C	16	up to 120°C	5	up to 77°F	232.1	up to 200°F	72.5	24	17.6	348.1	253.8
1832	1/2" to 1"	up to 120°C	10	up to 120°C	10	up to 248°F	145	up to 248°F	145	15	11	217.6	159.5
PRV4	1/2" to 4"	up to 80°C	6	up to 80°C	6	up to 176°F	87	up to 176°F	87	9	6.6	131	96



## COMPRESSION VALVES

ALL COMPRESSION VALVE PRODUCTS													
Product	Size	Max. working pressure (bar)				Max. working pressure (psi)				Test pressure (bar) (psi)			
		Temp	bar	Temp	bar	Temp	psi	Temp	psi	Shell	Seat	Shell	Seat
Any Compression Valve products	15 to 18mm	30°C	16	110°C	6	77°F	232.1	230°F	87	24	17.6	348	255.3

CHECK VALVES													
Product	Size	Max. working pressure (bar)				Max. working pressure (psi)				Test pressure (bar) (psi)			
		Temp	bar	Temp	bar	Temp	psi	Temp	psi	Shell	Seat	Shell	Seat
K424, K4424, K4424CP	15 to 28mm	95°C	10			up to 203°F	14			15	11		

BALLOFIX ISOLATING BALL VALVES													
Product	Size	Max. working pressure (bar)				Max. working pressure (psi)				Test pressure (bar) (psi)			
		Temp	bar	Temp	bar	Temp	psi	Temp	psi	Shell	Seat	Shell	Seat
Ballofix	15 to 28mm	max 120°C	16	max 120°C	16	248°F	232.1	248°F	232.1	24	17.6	348.1	253.8
Ballofix	1/4" to 1	max 120°C	16	max 120°C	16	248°F	232.1	248°F	232.1	24	17.6	348.1	253.8

## FLANGED VALVES

GATE VALVES													
Product	Size	Max. working pressure (bar)				Max. working pressure (psi)				Test pressure (bar) (psi)			
		Temp	bar	Temp	bar	Temp	psi	Temp	psi	Shell	Seat	Shell	Seat
V950	DN50 to DN300	120°C	16	230°C	11.8	248°F	232.1	446°F	171.1	24	17.6	348.1	253.8
V951	DN65 to DN200	120°C	6			248°F	145	446°F	101.3	9	6.6	217.6	159.5

BUTTERFLY VALVES													
Product	Size	Max. working pressure (bar)				Max. working pressure (psi)				Test pressure (bar) (psi)			
		Temp	bar	Temp	bar	Temp	psi	Temp	psi	Shell	Seat	Shell	Seat
V905, V905G V906, V906G	DN65 to DN300	120°C	16	120°C	16	248°F	232.1	248°F	232.1	24	17.6	348.1	253.8
V907, V907G	DN65 to DN300	120°C	6	85°C	6	-	81	-	81	9	7.6	131	107



## 3.0 TECHNICAL DATA

# PRESSURE AND TEMPERATURE RATINGS

### FLANGED VALVES - CONTINUED

BALLMAX BALL VALVES													
Product	Size	Max. working pressure (bar)				Max. working pressure (psi)				Test pressure (bar) (psi)			
		Temp	bar	Temp	bar	Temp	psi	Temp	psi	Shell	Seat	Shell	Seat
PB1006	DN65 to DN500	165°C	16	185°C	5	329°F	232	365°F	725	24	17.6	348	255.2
PB1005	DN15 to DN50	100°C	16	165°C	16	212°F	580	329°F	232	60	44	870	638

CHECK VALVES													
Product	Size	Max. working pressure (bar)				Max. working pressure (psi)				Test pressure (bar) (psi)			
		Temp	bar	Temp	bar	Temp	psi	Temp	psi	Shell	Seat	Shell	Seat
V909	DN50 to DN300	120°C	16	110°C	16	248°F	232.1	248°F	232.1	24	17.6	348.1	253.8
V911	DN80 to DN150	120°C	16	120°C	16	248°F	232.1	248°F	232.1	24	17.6	348.1	253.8
V914	DN65 to DN300	120°C	16	230°C	11.8	248°F	232.1	446°F	171.1	24	17.6	348.1	253.8

STRAINERS													
Product	Size	Max. working pressure (bar)				Max. working pressure (psi)				Test pressure (bar) (psi)			
		Temp	bar	Temp	bar	Temp	psi	Temp	psi	Shell	Seat	Shell	Seat
V912	DN65 to DN300	120°C	16	230°C	13	248°F	232.1	428°F	188.5	24	17.6	348.1	253.8

### WELD VALVES

BALL VALVES													
Product	Size	Max. working pressure (bar)				Max. working pressure (psi)				Test pressure (bar) (psi)			
		Temp	bar	Temp	bar	Temp	psi	Temp	psi	Shell	Seat	Shell	Seat
PB1002	DN15 to DN50	up to 100°C	40	max 165°C	16	up to 212°F	580.2	max 329°F	232.1	60	44	870.2	638.2
PB1003	DN65 to DN500	up to 100°C	25	max 165°C	16	up to 212°F	362.6	max 329°F	232.1	37.5	27.5	543.9	398.9
PB1004	DN65 to DN500	up to 100°C	40	max 165°C	16	up to 212°F	580.2	max 329°F	232.1	60	44	870.2	638.2

SERVICE VALVES													
Product	Size	Max. working pressure (bar)				Max. working pressure (psi)				Test pressure (bar) (psi)			
		Temp	bar	Temp	bar	Temp	psi	Temp	psi	Shell	Seat	Shell	Seat
PB1007	DN40 to DN250	up to 100°C	25	max 165°C	16	up to 212°F	362.6	max 329°F	232.1	37.5	27.5	543.9	398.9



CONNECT + CONTROL

### PN16 PUSH-FIT VALVES

PT500, PT500T, XT500, PT550, PT550T, PT550EL, XT550, XT550EL, TX300, PT1070/125, PT1070/125LS, PT1068, PT1068LS, XT1068, XT1068LS, PT1060A, PT913, PT5PRV

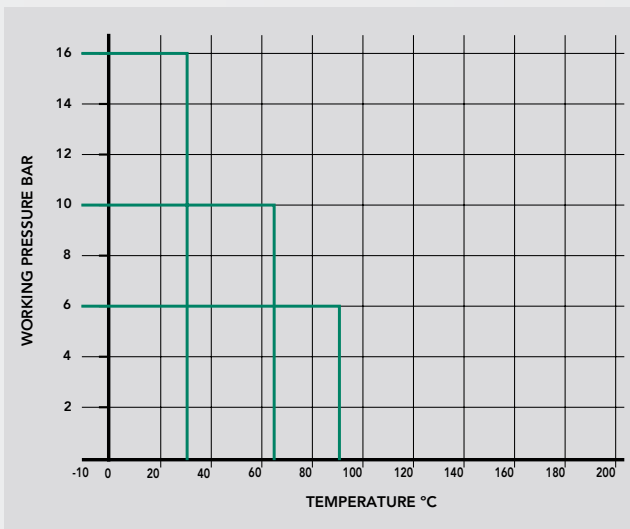

### PN16 PRESS-FIT VALVES

PS500, PS500T, PSU500, PSU500EL, PS550, PS550T, PS550EL, PSU550, PSU550EL, PS1070/125, PS1070/125LS, PSU1070/125, PSU1070/125LS, PS1068, PS1068LS, PSU1068, PSU1068LS, PS1078, PS1078LS, PSU1078, PSU1078LS, PS1060A, PSU1060A, PS4426, PSU4426, PS913, PSU913, PS4PRV, PSU4PRV

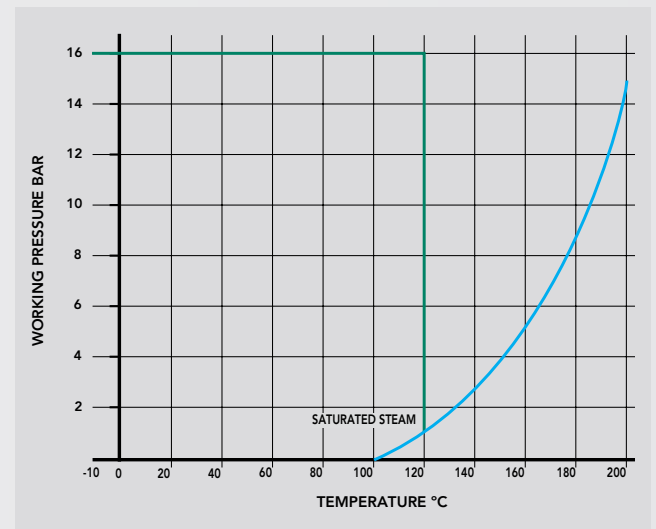

### PN40 THREADED VALVES

PB700, PB700T, PB1000, PB1001, PB1002

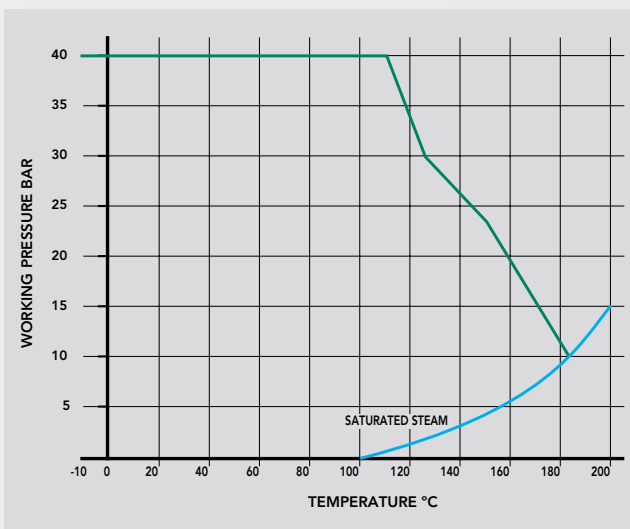

### PN25 THREADED VALVES

PB500, PB500T, PB500EL, PB550, PB550T, PB550LS, PB550EL, 1062, 1111BV, 1060A

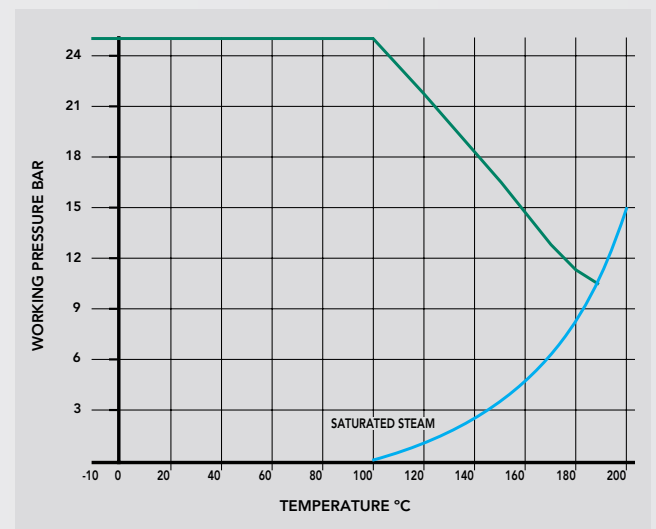



## 3.0 TECHNICAL DATA

# PRESSURE AND TEMPERATURE RATINGS

### 25BAR/16BAR THREADED VALVES

PB100

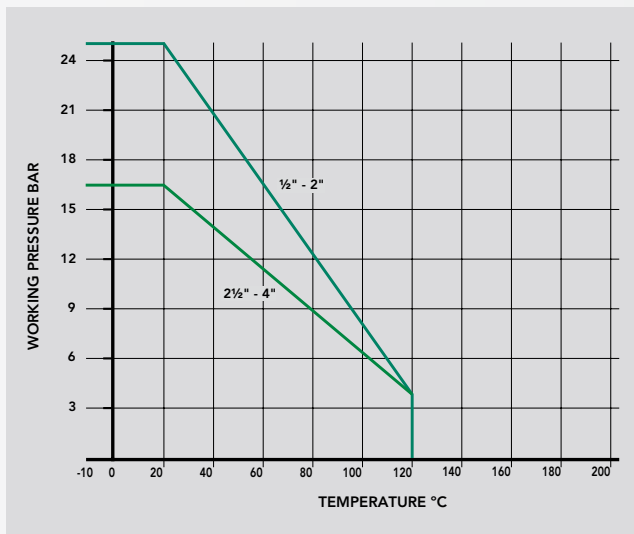

### PN10 THREADED VALVES

PB50HU, PB50, PB50AT, PB52HU

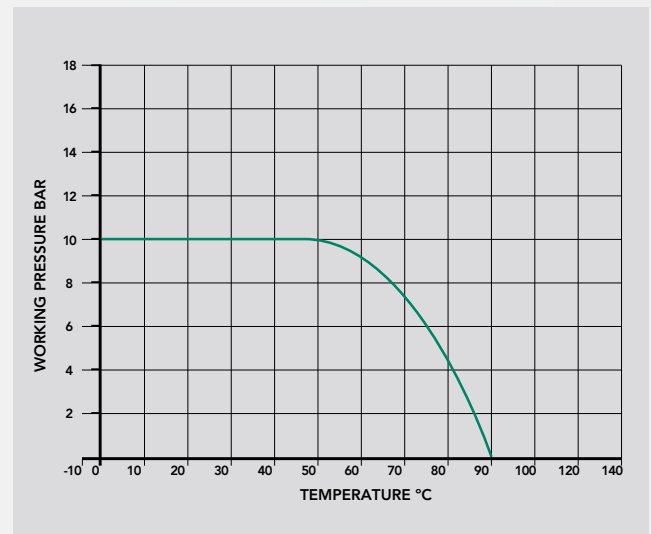

### PN20 THREADED VALVES

PB560, PB560EXT, 1070/125, 1070/125LS, 1068, 1068LS, 1078, 1078LS

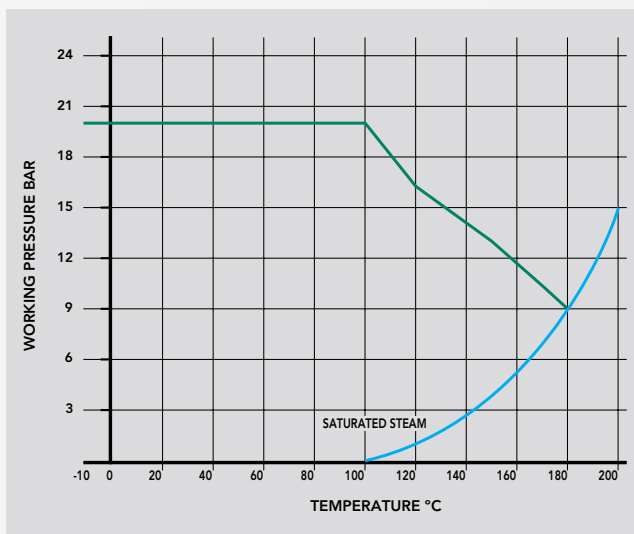

### PN32 THREADED VALVES

1072, 1029, 1031, 1039

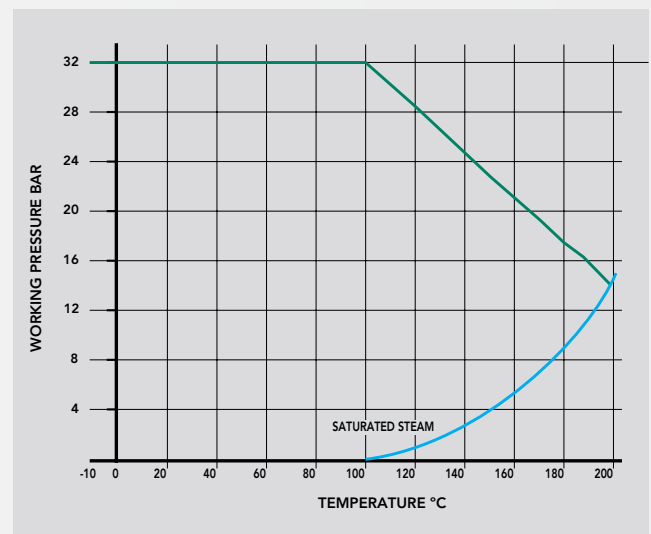



**17.5BAR/93°C THREADED VALVES**

1065

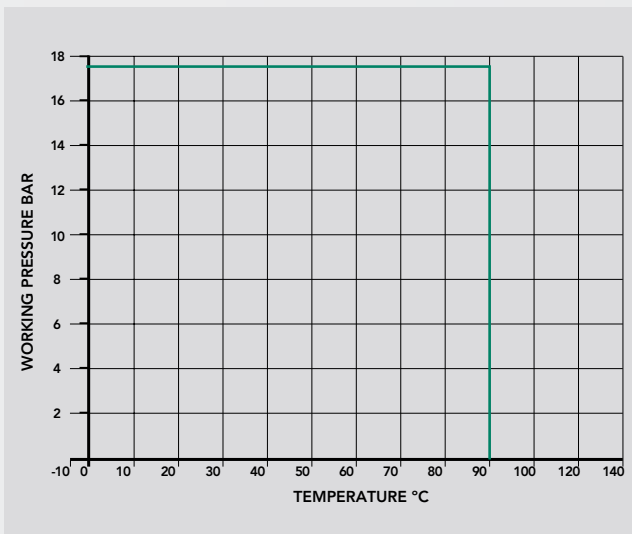

**8/10/12BAR/90°C THREADED VALVES**

1063, 1064

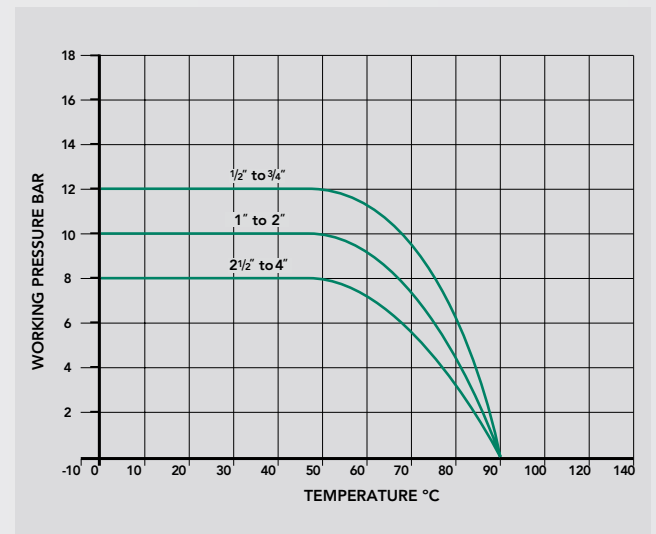

**PN16 THREADED VALVES**

V913

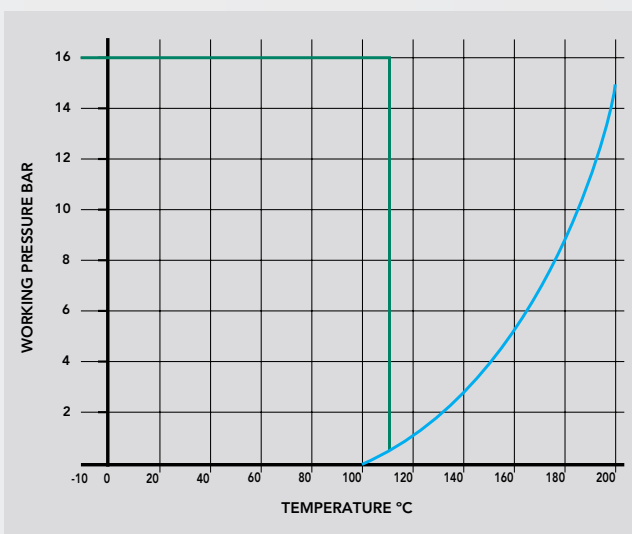

**PN10 THREADED VALVES**

PB60HU, 1832

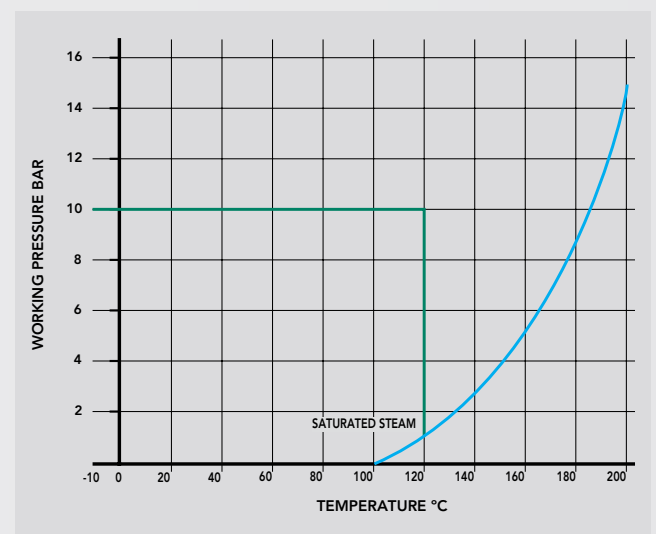





## 3.0 TECHNICAL DATA

# PRESSURE AND TEMPERATURE RATINGS

### PN16 COMPRESSION VALVES

63, 63LS, K416, K416LS, K416GM, K416GM LS, PB300, PB300T, PB350, PB350T, PB350LS, PB350EL

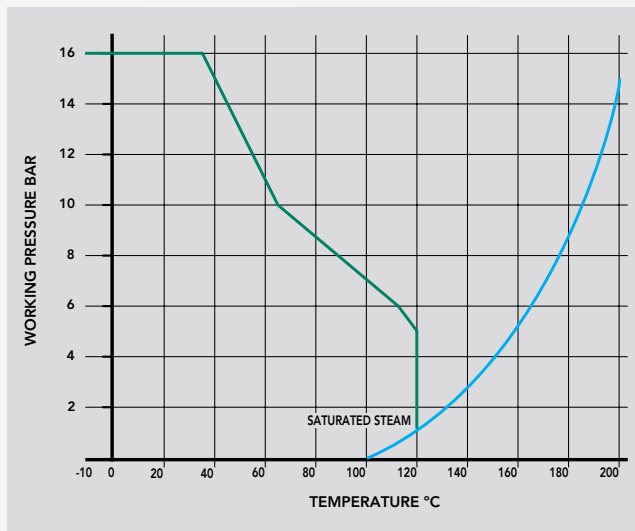

### THERMOSTATIC MIXING VALVES

PEG402, PEG402UA, PEG402UAX

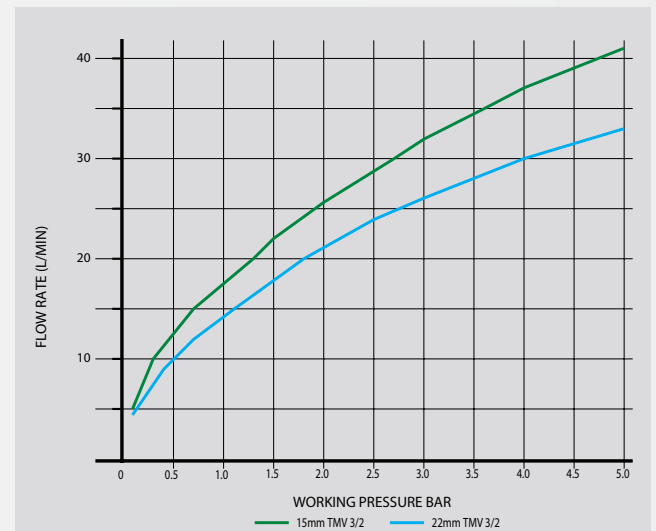

### PN16 FLANGED VALVES

V950

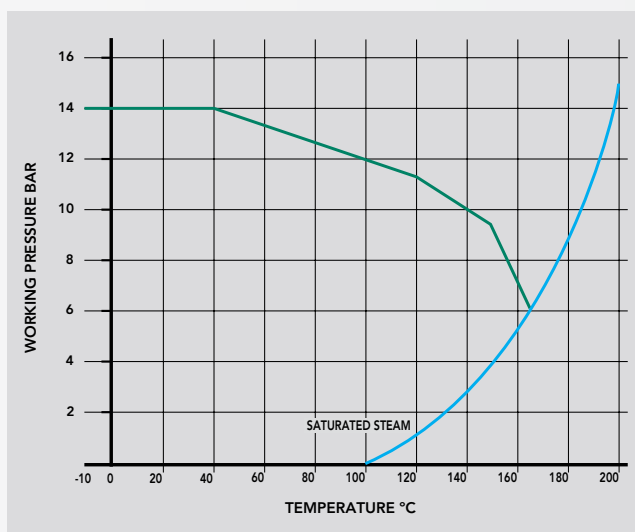

### PN6 FLANGED VALVES

V951

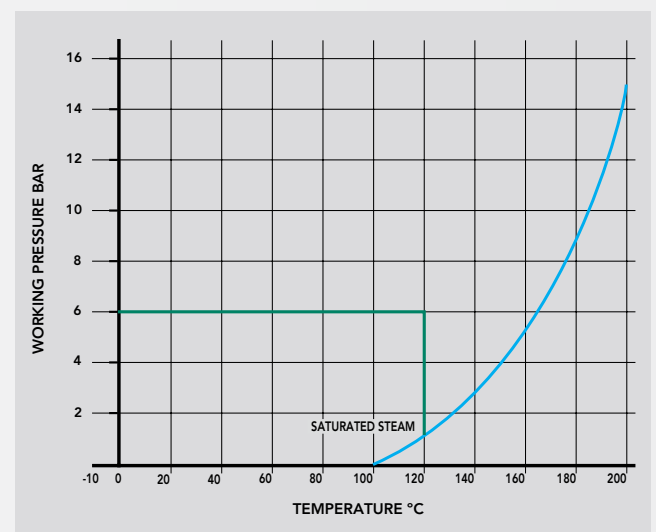





**PN16 FLANGED VALVES**

V905, V905G, V906, V906G, V909, V911, V914, V912

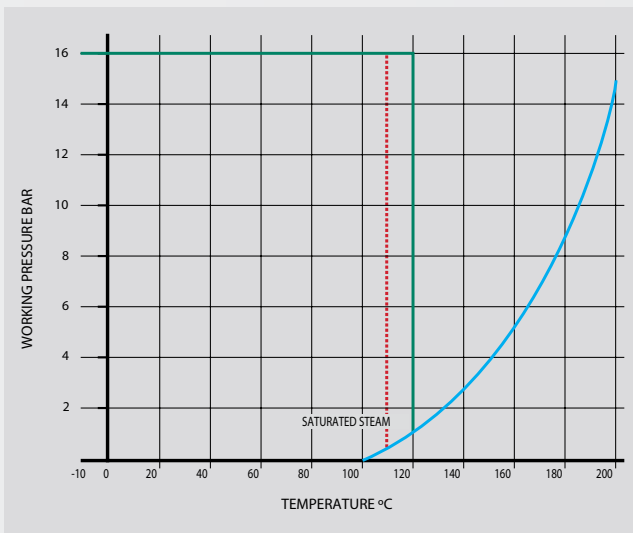

**PN16 FLANGED VALVES**

PB1006

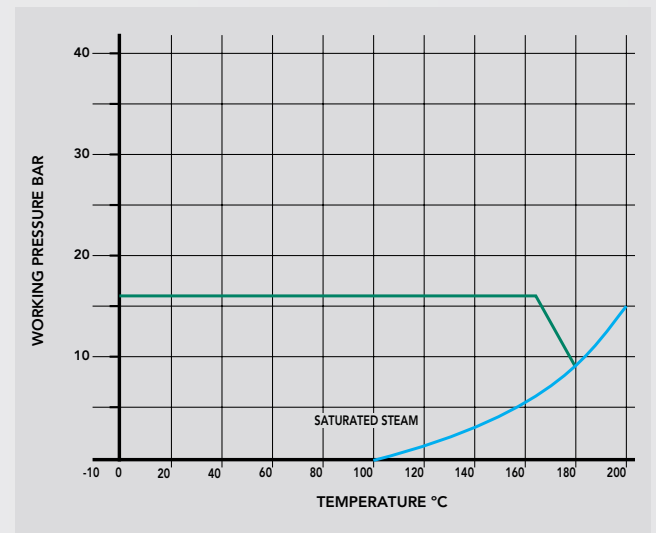

**PN6 THREADED AND FLANGED VALVES**

V907, V907G

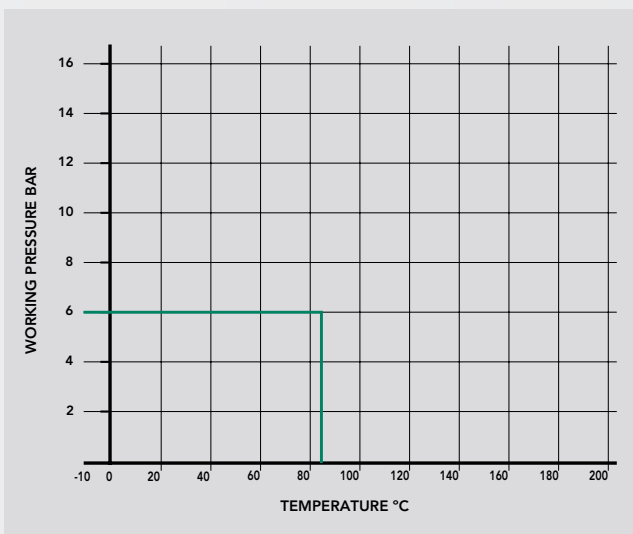

**PN25 WELD VALVES**

PB1004, PB1003, PB1007

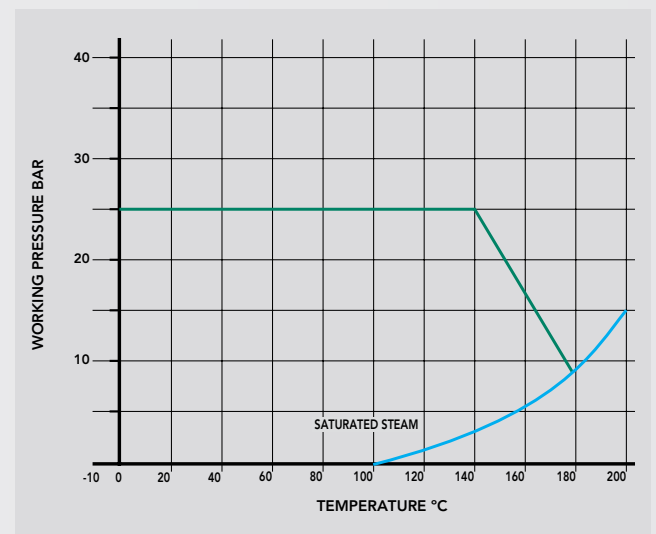



## 3.0 TECHNICAL DATA

### TECHNICAL SUITABILITY

#### QUARTER TURN VALVES

Product	VALVE SUITABILITY							
	Steam	Water	Oil	Air*	Gas Inert	Gas Combustible	Gas Corrosive	Gas Oxygen
PT500, PT500T, XT500, PT550, PT550T, PT550EL, XT550, XT550EL, PS500, PS500T, PSU500, PSU500EL, PS550, PS550T, PS550EL, PSU550, PSU550EL, TX300	—	✓	—	—	—	—	—	—
PB700, PB700T, PB500 Yellow, PB300 Yellow, PB300T Yellow, PB300 Green, PB300T Green, PB300 Red, PB300T Red, PB300 Blue, PB300T Blue	✓	✓	✓	✓	✓	✓†	✓††	—
PB500, PB500MF, PB500MF T, PB500T, PB500EL, PB500DR, PB500DR, PB550DR, PB550DR T, PB550DR LS, PB550EL, PB560, PB560EXT, PB350, PB350T, PB350LS, PB350EL	✓	✓	✓	✓	—	—	—	—
PB100	—	✓	✓	✓	—	—	—	—
PB50HU, PB50, PB52HU, 1111BV	—	✓	✓	—	—	—	—	—

\*Air to maximum 10bar

#### GATE VALVES

Product	VALVE SUITABILITY							
	Steam	Water	Oil	Air*	Gas Inert	Gas Combustible	Gas Corrosive	Gas Oxygen
PT1070/125, PT1070/125LS, PT1068, PT1068LS, XT1068, XT1068LS, PS1070/125, PS1070/125LS, PSU1070/125, PSU1070/125LS, PS1068, PS1068LS, PSU1068, PSU1068LS, PS1078, PS1078LS, PSU1078, PSU1078LS, V950, V951	—	✓	—	—	—	—	—	—
1072, 1070/125, 1070/125LS, 1065, 1068, 1068LS, 1078, 1078LS, 63, 63LS, K416, K416LS, K416GM, K416GMLS	—	✓	✓	—	—	—	—	—

<sup>†</sup>The valves are suitable for British Gas Applications Family Gases 1, 2 and 3. <sup>††</sup>Suitable in applications where moisture is completely absent.



## CHECK VALVES

VALVE SUITABILITY								
Product	Steam	Water	Oil	Air*	Gas Inert	Gas Combustible	Gas Corrosive	Gas Oxygen
PT1060A, PS1060A, PSU1060A, PS4426, PSU4426, K4426, K424, K4424, K4424CP, V909, V914, V912	—	✓	—	—	—	—	—	—
1060A, 1039	✓	✓	✓	✓	—	—	—	—
1063, 1064, 2064	—	✓	—	✓	—	—	—	—
*Air to maximum 5bar								

## STRAINERS

VALVE SUITABILITY								
Product	Steam	Water	Oil	Air*	Gas Inert	Gas Combustible	Gas Corrosive	Gas Oxygen
PT913, PS913, PSU913, V913, 1059	—	✓	—	—	—	—	—	—

## PRESSURE REDUCING VALVE

VALVE SUITABILITY								
Product	Steam	Water	Oil	Air*	Gas Inert	Gas Combustible	Gas Corrosive	Gas Oxygen
PT5PRV, PS5PRV, PRV4	—	✓	—	—	—	—	—	—

## BALLOFIX ISOLATING BALL VALVES

VALVE SUITABILITY								
Product	Steam	Water	Oil	Air*	Gas Inert	Gas Combustible	Gas Corrosive	Gas Oxygen
6381ZA, 6481ZA, 6381ZP, 6481ZP, 7310ZA, 7331ZA, 4381ZA, 4381ZP, 8310ZA, 8410ZA, 8510ZA, 3200YA, 3200ZA, 3205YA, 3205ZA, 3210YA, 5095BA, 5095CA, 3250ZA, 3355BK, 3455BK, 3555BK, 3755BK, 3855BK, 3310YP, 3310ZP, 5060BA, 3410YA, 3410ZA, 3510YA, 3510ZA, 3350YA, 3350ZA, 3310YA, 3310ZA, 3450YA, 3450ZA, 3550YA, 1581YA, 1581ZA, 3140ZA, 3140ZP, 3160ZA, 3331YP, 3331ZP, 5045CA, 5035CA, 33615ZA, 33615ZP, 3375YA, 3380YA, 3380YP, 3380ZA, 3380ZP, 3381ZAF12, 3390ZA, 3431YA, 3331YA, 3331ZA, 3381YA, 3381YP, 3381ZA, 3381ZP, 3381ZM, 3481YA, 3481ZA, 3581YA, 3581ZA	—	✓	—	—	—	—	—	—
33504GU	—	✓	—	—	✓	✓†	✓††	—

## BALLOFIX FILTER VALVES

VALVE SUITABILITY								
Product	Steam	Water	Oil	Air*	Gas Inert	Gas Combustible	Gas Corrosive	Gas Oxygen
33624ZP, 34622ZA	—	✓	—	—	—	—	—	—

†The valves are suitable for British Gas Applications Family Gases 1, 2 and 3. ††Suitable in applications where moisture is completely absent. These are general guidelines and the manufacturer can be contacted to confirm suitability.



## 3.0 TECHNICAL DATA

### TECHNICAL SUITABILITY

#### HENCO MULTI-LAYER VALVES

Product	VALVE SUITABILITY							
	Steam	Water	Oil	Air*	Gas Inert	Gas Combustible	Gas Corrosive	Gas Oxygen
MLH500, MLH500EL, MLH550, MLH550EL, MLH1070/125, MLH1070/125LS, MLH1068, MLH1068LS, MLH1078, MLH1078LS, MLH4426, MLH913, MLC500, MLC500EL, MLC550, MLC550EL, MLC1070/125, MLC1070/125LS, MLC1068, MLC1068LS, MLC1078, MLC1078LS, MLC4426, MLC913	—	✓	—	—	—	—	—	—

#### BALLOMAX STEEL BALL VALVES

Product	VALVE SUITABILITY							
	Steam	Water	Oil	Air*	Gas Inert	Gas Combustible	Gas Corrosive	Gas Oxygen
PB1000, PB1001, PB1002, PB1004, PB1003, PB1007	—	✓	—	—	—	—	—	—
PB1006, PB1005	—	✓	✓	✓	—	—	—	—

#### GLOBE VALVES

Product	VALVE SUITABILITY							
	Steam	Water	Oil	Air*	Gas Inert	Gas Combustible	Gas Corrosive	Gas Oxygen
1029	✓	✓	✓	✓	✓	✓	✓	—
1031	✓	✓	✓	✓	—	—	—	—

#### BALLOFIX CHECK VALVES

Product	VALVE SUITABILITY							
	Steam	Water	Oil	Air*	Gas Inert	Gas Combustible	Gas Corrosive	Gas Oxygen
0015YA	—	✓	—	—	—	—	—	—

#### BALLOFIX SERVICE VALVES

Product	VALVE SUITABILITY							
	Steam	Water	Oil	Air*	Gas Inert	Gas Combustible	Gas Corrosive	Gas Oxygen
3160YA, 3140YA	—	✓	—	—	—	—	—	—

#### DRAIN COCKS AND VALVES

Product	VALVE SUITABILITY							
	Steam	Water	Oil	Air*	Gas Inert	Gas Combustible	Gas Corrosive	Gas Oxygen
PB60HU	—	✓	✓	✓	—	—	—	—
1832	—	✓	✓	—	—	—	—	—



### IN-LINE THERMOSTATIC MIXING VALVES

VALVE SUITABILITY								
Product	Steam	Water	Oil	Air*	Gas Inert	Gas Combustible	Gas Corrosive	Gas Oxygen
PEG402, PEG402UA, PEG402UAX TX402, TX402UA, TX402UAX	—	✓	—	—	—	—	—	—

### BUTTERFLY VALVES

VALVE SUITABILITY								
Product	Steam	Water	Oil	Air*	Gas Inert	Gas Combustible	Gas Corrosive	Gas Oxygen
V905, V905G, V906, V906G	—	✓	—	—	—	—	—	—
V907, V907G	—	✓	—	—	✓	✓†	✓††	—

### WATER HAMMER ARRESTOR

VALVE SUITABILITY								
Product	Steam	Water	Oil	Air*	Gas Inert	Gas Combustible	Gas Corrosive	Gas Oxygen
PEG62	—	✓	—	—	—	—	—	—

\*The valves are suitable for British Gas Applications Family Gases 1, 2 and 3. †Suitable in applications where moisture is completely absent. ††These are general guidelines and the manufacturer can be contacted to confirm suitability.





## 3.0 TECHNICAL DATA

### TECHNICAL SUITABILITY



#### GAS APPLICATIONS

Where indicated Pegler valves are suitable for use with water, steam, oil and certain gases. It is common practice for manufacturers to claim that their valves are suitable with gas. In fact, gases vary widely in their properties and the following explanation is offered for guidance.

Gases may be classified as follows:

##### **Class 1. INERT**

Air, argon, carbon dioxide, helium, nitrogen

##### **Class 2. COMBUSTIBLE**

Hydrogen, methane, natural gas, town gas

##### **Class 3. CORROSIVE**

Chlorine, sulphur dioxide

##### **Class 4. OXYGEN**

#### THE SUITABILITY OF PEGLER YORKSHIRE VALVES FOR HANDLING DIFFERENT CLASSES OF GAS

##### **Class 1. INERT**

Entirely suitable. We recommend the renewable disk valves for preference. When ordering please state the specific purpose for which the valve is required.

##### **Class 2. COMBUSTIBLE**

There is no technical reason why our valves should not be used. However, in view of the hazards involved and the special requirements and approvals required by British Gas, we do not make any general recommendation for this class of gas unless specified, but will be pleased to discuss specific applications.

##### **Class 3. CORROSIVE**

Copper alloy valves are only suitable for such application if moisture is completely absent.

##### **Class 4. OXYGEN**

Oxygen can react dangerously with oils and greases, and normal lubricants cannot be used so brass/bronze valves are not recommended for this use.

#### EU Construction Products Directive 89/106 EEC and CE Marking.

PB700, PB500Y and PB300 QT ball valves have been tested in accordance with hEn331:1998+A1:2010 attention level 1. A certificate of conformity has been issued by a Notified Body from which a Declaration of Performance has been derived. This DoP is available on the Pegler Yorkshire website.



### 3.0 TECHNICAL DATA

## MATERIALS SPECIFICATION

CONNECT + CONTROL

#### QUARTER TURN BALL VALVES

Component	PT500, PT500T, XT500, PS500, PS500T, PSU500, PSU500EL, PB500, PB500MF, PB500DC, PB500T, PB500EL
Body	Forged brass, chrome plated (1/4" to 2") Gravity die cast brass, chrome plated (21/2" to 4")
End piece	Forged brass, chrome plated (1/4" to 2") Gravity die cast brass, chrome plated (21/4" to 4")
Ball	Brass bar, chrome plated (1/4" to 1/2") Forged brass, chrome plated (3/4" to 2") Gravity die cast brass, chrome plated (21/2" to 4")
Stem	Brass bar
Seats	PTFE (Teflon)
Thrust washer	PTFE (Teflon)
Stem 'O' ring	Viton
Lever handle	High temperature PVC insulated zinc plated steel
Nut (self locking)	Zinc plated steel
Tee handle	Aluminium, painted
Security screws	Nickel plated brass
End connection	DZR brass body (PT500/PT500T) (15 to 54) (15 to 28)
End connection 'O' ring	EPDM (PT500/PT500T) (15 to 54) (15 to 28)
Grab ring	Stainless steel, SS316
End connection	Gunmetal body (PS500/PS500T) (15 to 54) (15 to 28)
End connection 'O' ring	EPDM (PS500/PS500T) (15 to 54) (15 to 28)
Sleeve	Brass (EL)
Ext Stem	Brass (EL)
Fixing screw	Steel (EL)
Washer	Brass (EL)

#### QUARTER TURN BALL VALVES

Component	PT550, PT550T, PT550EL, XT550, XT550EL, PS550, PS550T, PS550EL, PSU550, PSU550EL
Body	DZR brass
Ball	Brass, chrome plated
Seat/thrust washer	PTFE (Teflon)
Stem 'O' ring	Viton
Lever handle	High temperature PVC insulated
Nut (self locking)	Zinc plated steel
Tee handle	Aluminium, painted
Security screws	Nickel plated brass
Stem	DZR brass
End connection	DZR brass body (PT550/PT550T) (15 to 54) (15 to 28)
End connection 'O' ring	EPDM (PT550/PT550T) (15 to 54) (15 to 28)
Grab ring	Stainless steel, SS316 (PT550/PT550T) (15 to 54) (15 to 28)
End connection	Gunmetal body (PS550/PS550T) (15 to 54) (15 to 28)
End connection 'O' ring	EPDM (PS550/PS550T) (15 to 54) (15 to 28)
Sleeve	Brass (EL)
Ext Stem	Brass (EL)
Fixing screw	Steel (EL)
Washer	Brass (EL)

#### BALLOFIX ISOLATING BALL VALVES

Component	6381ZA, 7310ZA, 7331ZA, 4381ZA, 4481ZA, 8310ZA, 8410ZA, 8510ZA, 3200ZA, 3202ZA, 3250ZA, 3410ZA, 3510ZA, 3350ZA, 3310ZA, 3450ZA, 1581ZA, 3140ZA, 3160ZA, 33165ZA, 3380ZA, 3381ZAF12, 3390ZA, 34622ZA, 3331ZA, 3381ZA, 3381ZM, 3481ZA, 3581ZA
Body	DZR brass, chrome plated
Ball	DZR brass, nickel plated
'O' rings	EPDM
Handle (where fitted)	Nylon PA6.6 (30% glass reinforced)
Compression nut	Forged brass, chrome plated
Compression cone	Brass

#### BALLOFIX ISOLATING BALL VALVES

Component	6381ZP, 3310ZP, 33624ZP, 3140ZP, 33165ZP, 3380ZP, 3381ZP
Body	DZR brass, chrome plated
Ball	DZR brass, nickel plated
'O' rings	EPDM
Handle	Nylon PA6.6 (30% glass reinforced)
Compression nut	Forged brass, chrome plated
Compression cone	Brass



## 3.0 TECHNICAL DATA

# MATERIALS SPECIFICATION

### BALLOFIX ISOLATING BALL VALVES

Component	3200YA, 3205YA, 3210YA, 5095BA, 5095CA, 3355BK, 3455BK, 3555BK, 3755BK, 3855BK, 3355BK, 3310YP, 33504GU, 5060BA, 3410YA, 3510YA, 3350YA, 3310YA, 3450YA, 3550YA, 1581YA, 3331YP, 5045CA, 5035CA, 3375YA, 3380YA, 3380YP, 3431YA, 0015YA, 3160YA, 3331YA, 3381YA, 3381YP, 3481YA, 3581YA, 3140YA
Body	DZR brass
Ball	DZR brass, nickel plated
Ball seal	EPDM/nitrile (33504BGA)
Compression nut	Forged brass
Compression cone	Brass

### GATE VALVES

Component	PT1070/125, PS1070/125, PSU1070/125, 1070/125
Body	Gunmetal
Bonnet	Forged brass (1/4" to 3") Gravity die cast brass (4")
Stem	Brass bar
Wedge	Brass
Stem ring	Brass bar
Gland	Brass bar
Gland Nut	Brass bar (1/4" to 1") Forged brass (1 1/4" to 4")
Handwheel	Aluminium
Handwheel nut	Brass bar
Gland packing	PTFE
Rating disc	Aluminium
End connection	DZR brass body (PT1070/125) (15 to 54)
End connection 'O' ring	EPDM (PT1070/125) (15 to 54)
End connection	Gunmetal body (PS1070/125) (15 to 54)
End connection 'O' ring	EPDM (PS1070/125) (15 to 54)
Grab ring	Stainless steel SS316 (PT1070/125) (15 to 54)

### GATE VALVES

Component	PS1070/125LS, PT1070/125LS, PSU1070/125LS, 1070/125LS
Body	Gunmetal
Bonnet	Forged brass (1/4" to 3") Gravity die cast brass (4")
Stem	Brass bar
Wedge	Brass
Stem ring	Brass bar
Gland	Brass bar
Gland Nut	Brass bar (1/4" to 1") Forged brass (1 1/4" to 4")
Handwheel	Aluminium
Handwheel nut	Brass bar
Gland packing	PTFE
Rating disc	Aluminium
Lockshield	Brass
End connection	DZR brass body (PT1070/125, PT1070/125LS) (15 to 54)
End connection 'O' ring	EPDM (PT1070/125, PT1070/125LS) (15 to 54)
Grab ring	Stainless steel SS316 (PT1070/125, PT1070/125LS) (15 to 54)
End connection	Gunmetal body (PS1070/125, PS1070/125LS) (15 to 54)
End connection 'O' ring	EPDM (PS1070/125, PS1070/125LS) (15 to 54)

### CHECK VALVES

Component	PT1060A, PS1060A, PSU1060A, 1060A
Body	Gunmetal
Cap	Forged brass (1/4" to 2") Gunmetal (2 1/2" to 4")
Valve	Gunmetal
Swinger	Brass bar (1/4" to 1") Gunmetal (1 1/4" to 4")
Swinger pin	Brass bar
Swinger pin cap	Brass bar (2 1/2" to 4")
Nut	Brass bar
Rating disc	Tinned iron sheet
End connection	DZR brass body (PT1060A) (15 to 54)
End connection 'O' ring	EPDM (PT1060A) (15 to 54)
Grab ring	Stainless steel, SS316 (PT1060A) (15 to 54)
End connection	Gunmetal body (PS1060A) (15 to 54)
End connection 'O' ring	EPDM (PS1060A) (15 to 54)





## GATE VALVES

Component	PT1068, PT1068LS, XT1068, XT1068LS, PS1068, PS1068LS, PSU1068, PSU1068LS, 1068, 1068LS
Body	Forged brass
Bonnet	Forged brass
Stem	Brass bar
Wedge	Forged brass
Stem ring	Brass bar
Gland	Brass bar
Gland Nut	Brass bar
Handwheel	Aluminium
Handwheel nut	Brass bar
Gland packing	PTFE
Rating disc	Aluminium
Lockshield	Brass bar
End connection	DZR brass body (PT1068) (15 to 54)
End connection 'O' ring	EPDM (PT1068) (15 to 54)
Grab ring	Stainless steel SS316 (PT1068) (15 to 54)
End connection	Gunmetal body (PS1068) (15 to 54)
End connection 'O' ring	EPDM (PS1068) (15 to 54)

## STRAINERS

Component	PT913, PS913, PSU913, V913
Body	Gunmetal
Cap	Gunmetal
Screen	Stainless steel
Gasket	Asbestos free (non stick)
End connection	DZR brass body (PT913)
End connection 'O' ring	EPDM (PT913)
Grab ring	Stainless steel, SS316 (PT913)
End connection	Gunmetal body (PS913)
End connection 'O' ring	EPDM (PS913)

## PRESSURE REDUCING VALVE

Component	PSU4PRV, PS4PRV, PRV4
Body	CW617N
Internal parts	CW617N
Seat	Stainless steel
Bar	CW614N
Flat gasket	FASIT
'O' ring	NBR
End connection	DZR brass body
End connection 'O' ring	EPDM
End connection	Gunmetal

## GATE VALVES

Component	PS1078, PS1078LS, PSU1078, PSU1078LS, 1078, 1078LS
Body	DZR brass
Bonnet	DZR brass
Stem	DZR brass
Wedge	DZR brass
Stem ring	DZR brass
Gland	Brass bar
Gland Nut	Brass bar
Handwheel	Aluminium
Handwheel nut	Brass
Gland packing	PTFE
Rating disc	Aluminium
Lockshield	Brass
End connection	Gunmetal body (PS1078, PS1078LS, PSU1078, PSU1078LS)
End connection 'O' ring	EPDM (PS1078, PS1078LS, PSU1078, PSU1078LS)

## CHECK VALVES

Component	PS4426, PSU4426, K4426
Body	DZR brass
Test plug	DZR brass
Non-return valve	Nylon
Test plug seal 'O' ring	WRAS approved elastnor
Circlip	Stainless steel
Washer	DZR copper alloy

## HENCO MULTI-LAYER QUARTER TURN BALL VALVES

Component	MLH500, MLH500EL, MLH550, MLH550EL, MLC500, MLC500EL, MLC550, MLC550EL
Body	Forged brass, chrome plated (1/4" to 2") Gravity die cast brass, chrome plated (21/2" to 4")
End piece	Forged brass, chrome plated (1/4" to 2") Gravity die cast brass, chrome plated (21/4" to 4")
Ball	Brass bar, chrome plated (1/4" to 1/2") Forged brass, chrome plated (3/4" to 2") Gravity die cast brass, chrome plated (21/2" to 4")
Stem	Brass bar
Seats	PTFE (Teflon)
Thrust washer	PTFE (Teflon)
Stem 'O' ring	Viton
Lever handle	High temperature PVC insulated zinc plated steel
Nut (self locking)	Zinc plated steel
Tee handle	Aluminium, painted
Security screws	Nickel plated brass
End connection	PVDF/brass range union
End connection adapter	DZR



## 3.0 TECHNICAL DATA

# MATERIALS SPECIFICATION

### HENCO MULTI-LAYER GATE VALVES

Component	MLH1070/125, MLH1070/125LS, MLC1070/125, MLC1070/125LS
Body	Gunmetal
Bonnet	Forged brass
Stem	Brass bar
Wedge	Brass
Stem ring	Brass bar
Gland	Brass bar
Gland Nut	Brass bar (1/4" to 1") Forged brass (1 1/4" to 4")
Handwheel	Aluminium
Handwheel nut	Brass bar
Gland packing	PTFE
Rating disc	Aluminium
Lockshield	Brass
End connection	PVDF/Brass
End connection adapter	DZR

### HENCO MULTI-LAYER GATE VALVES

Component	MLH1068, MLH1068LS, MLC1068, MLC1068LS
Body	Forged brass
Bonnet	Forged brass
Stem	Brass bar
Wedge	Forged brass
Stem ring	Brass bar
Gland	Brass bar
Gland Nut	Brass bar
Handwheel	Aluminium
Handwheel nut	Brass bar
Gland packing	PTFE
Rating disc	Aluminium
Lockshield	Brass bar
End connection	PVDF/Brass
End connection adapter	DZR

### HENCO MULTI-LAYER GATE VALVES

Component	MLH1078, MLH1078LS, MLC1078, MLC1078LS
Body	DZR brass
Bonnet	DZR brass
Stem	DZR brass
Wedge	DZR brass
Stem ring	DZR brass
Gland	Brass bar
Gland Nut	Brass bar
Handwheel	Aluminium
Handwheel nut	Brass
Gland packing	PTFE
Rating disc	Aluminium
Lockshield	Brass
End connection	PVDF/Brass
End connection adapter	DZR

### HENCO MULTI-LAYER CHECK VALVES

Component	MLH4426, MLC4426
Body	DZR brass
Test plug	DZR brass
Non-return valve	Nylon
Test plug seal 'O' ring	WRAS approved elastomer
Circlip	Stainless steel
Washer	DZR copper alloy
End connection	PVDF/Brass
End connection adapter	DZR

### HENCO MULTI-LAYER STRAINERS

Component	MLH913, MLC913
Body	Gunmetal
Cap	Gunmetal
Screen	Stainless steel
Gasket	Asbestos free (non stick)
End connection	PVDF/Brass
End connection adapter	DZR



### QUARTER TURN BALL VALVES

Component	PB700
Body	Forged brass, chrome plated (1/4" to 2") Gravity die cast brass, chrome plated (2 1/2" to 4")
End piece	Forged brass, chrome plated (1/4" to 2") Gravity die cast brass, chrome plated (2 1/2" to 4")
Ball	Brass bar, chrome plated (1/4" to 1/2") Forged brass, chrome plated (3/4" to 2") Gravity die cast brass, chrome plated (2 1/2" to 4")
Stem	Brass bar
Seats	PTFE (Teflon)
Thrust washer	PTFE (Teflon)
Stem 'O' ring	Viton
Lever handle	High temperature PVC insulated zinc plated steel
Nut (self locking)	Zinc plated steel
Tee handle	Aluminium, painted
Security screws	Nickel plated brass

### QUARTER TURN BALL VALVES

Component	PB550DR, PB550DR T, PB550DR LS, PB550EL
Body	DZR brass
Ball	Brass, chrome plated
Stem	DZR brass
Stem 'O' ring	Viton
Seat rings	PTFE (Teflon)
Lever handle	Steel
Tee handle	Aluminium, painted (PB550DR T)
Lever nut self locking	Zinc plated steel
Tee handle security screw	Nickel plated brass
Lockshield dust cap	Plastic (PB550DR LS)
Lockshield	Brass
Lockshield security screw	Brass
Sleeve	Brass (EL)
Ext Stem	Brass (EL)
Fixing screw	Steel (EL)
Washer	Brass (EL)

### QUARTER TURN BALL VALVES

Component	PB100
Body	Forged brass, chrome plated
End piece	Forged brass, chrome plated
Ball	Brass, chrome plated
Stem	Brass
Seats	PTFE
Lever handle	Dip-coated on CP steel
Handle nut	Steel
Friction washer	PTFE
'O' rings	Nitrile rubber

### BALL VALVE BIB TAPS

Component	PB50 HU, PB50, PB52 HU
Body	Brass, chrome plated
Cap	Brass, chrome plated
Ball	Brass (PB50 HU, PB50) Brass, chrome plated (PB52 HU)
Ball seal	PTFE
Spindle	Brass
Spindle seal	NBR
Hose pipe	Brass, chrome plated
Hose nut	Brass, chrome plated
Hose union 'O' ring	NBR
Lever	A3 steel (PB50 HU, PB50) Cast aluminium, painted black (PB52 HU)
Lever nut	Brass
Lever securing screw	Brass, chrome plated
Lever grip	PVC
Gland nut	Brass, chrome plated
Flow straightener	Polyethylene

### THREE WAY VALVES

Component	1111BV
Body	Forged brass, nickel plated
Body cap	Forged brass, nickel plated
Ball	Forged brass, chrome plated
Ball seal	PTFE
Stem	Brass, nickel plated
Lever	Steel, PVC coated
Nut	Steel, nickel plated

### COMBI BALL VALVES

Component	PB560, PB560EXT
Body	DZR brass
Tee handle	Aluminium, painted
Strainer mesh	Stainless steel
Exterior sleeve	PA6.6 - 20% GF
Securing screws	Iron, chrome plated
Stem extension	CW614N
Ball	Brass, chrome plated
Stem	DZR brass
'O' ring	EPDM
Ball seat	PTFE (Teflon)



## 3.0 TECHNICAL DATA

# MATERIALS SPECIFICATION

### BALLOMAX STEEL BALL VALVES

Component	PB1000, PB1001, PB1002, PB1004, PB1003
Body	Steel
Ball	Stainless steel
Seat	PTFE
Friction packing	PTFE, 20% C
'O' ring	EPDM, viton
Female end	Steel
Back up spring	Spring steel
Back up ring	Stainless steel
Neck ring, handle	Steel
Intermediate ring	Stainless steel
Stop pin	Steel hardened
Cap nut	Steel
Spindle guide	Steel
Spindle	Stainless steel

### GATE VALVES

Component	1072
Body	Gunmetal
Bonnet	Gunmetal
Stem	Gunmetal
Wedge	Gunmetal
Stem ring	Gunmetal
Gland	Brass bar
Gland nut	Brass bar
Handwheel	Aluminium
Handwheel nut	Brass bar
Gland packing	PTFE
Rating disc	Aluminium

### GATE VALVES

Component	1065
Body	Forged brass
Bonnet	Forged brass
Stem	Brass bar
Wedge	Forged brass
Gland Nut	Brass bar
Handwheel	Aluminium
Handwheel nut	Brass bar
Rating disc	Aluminium
'O' rings	Nitrile rubber

### GLOBE VALVES

Component	1029
Body	Gunmetal
Bonnet	Forged brass
Stem	Brass bar
Disk holder	Brass bar
Disk ring	Brass bar
Disk	Glass filled PTFE
Disk nut	Brass bar
Gland	Brass bar
Gland nut	Brass bar
Packing	PTFE
Handwheel	Aluminium
Handwheel nut	Brass bar
Rating disc	Aluminium

### GLOBE VALVES

Component	1031
Body	Gunmetal
Bonnet	Forged brass
Stem	Brass bar
Disk ring	Brass bar
Disk	Brass bar
Gland	Brass bar
Gland nut	Brass bar
Packing	PTFE
Handwheel	Aluminium
Handwheel nut	Brass bar
Rating disc	Aluminium

### CHECK VALVES

Component	1062
Body	Forged brass (1/2" to 3/4") Gravity die cast brass (1")
Cap	Forged brass
Swinger	Brass bar
Swinger pin	Brass bar
Bush	Brass bar
Valve	Brass bar
Nut	Brass bar
Rating disc	Aluminium

### CHECK VALVES

Component	1063
Body	Brass
Pin	ABS
Pin washer	ABS
Sealing washer	EPDM
Spring	Stainless steel



### CHECK VALVES

Component	1064
Body	Brass
Pin	ABS
Pin washer	ABS
Sealing washer	EPDM
Spring	Stainless steel
Filter	Stainless steel
Filter/body connection	ABS

### CHECK VALVES

Component	2064
Body	Brass
Pin	Stainless steel
Pin washer	Brass
Sealing washer	EPDM
Spring	Stainless steel
Filter	Stainless steel
Filter/body connection	Brass/ABS

### CHECK VALVES

Component	1039
Body	Gunmetal
Cap	Forged brass
Valve	Brass bar
Rating Disc	Aluminium

### STRAINERS

Component	1059
Body	Forged brass
Cap	Forged brass
Screen	Stainless steel
Gasket	Asbestos free (non stick)

### DRAIN VALVES

Component	PB60HU
Body	DZR brass
Cap	Brass bar
Hose union pipe	Brass
Strap	Nylon 6
Tee handle	Aluminium, painted
Locking screw	Brass
'O' ring	Viton
Stem	DZR brass
Ball	Brass

### GLAND COCK

Component	1832
Body	Gunmetal
Plug	Gunmetal
Gland	Brass bar (1/2" and 3/4") Forged brass (1")
Bolt	Brass bar
Gland Packing	PTFE
Lever	Cast iron
Pipe	Brass bar
Boss	Brass bar (1/2") Forged brass (3/4" and 1")
Cap	Brass bar
'O' ring	WRAS approved rubber
Washer	Akulon (3/4" and 1")
Strap	Nylon 6

### GATE VALVES

Component	63, 63LS
Body	Forged brass (Gunmetal 42mm and 54mm)
Bonnet	Forged brass
Stem	Brass bar
Wedge	Brass (Gunmetal 42mm and 54mm)
Stem ring	Brass bar
Gland	Brass bar
Gland Nut	Brass bar (15 and 22mm) Forged brass (28 to 54mm)
Handwheel	Aluminium
Handwheel nut	Brass bar
Rating disc	Aluminium
Lockshield	Brass bar (Prestex 63LS)
Compression nut	Forged brass, chrome plated
Compression cone	Brass

### GATE VALVES

Component	K416, K416LS
Body	Brass
Bonnet	Brass
Stem	Brass
Gland	Brass
Gland Nuts	Brass
Handwheel	Aluminium
Nameplate	Aluminium
Handle screw	Steel
Compression nut	Brass
Compression cone	Brass





## 3.0 TECHNICAL DATA

# MATERIALS SPECIFICATION

### GATE VALVES

Component	K416GM, K416GMLS
Body	Gunmetal
Bonnet	Gunmetal
Stem	Brass
Gland	Brass
Gland Nuts	Brass
Packaging flange and bolts	Brass
Handwheel	Aluminium
Nameplate	Aluminium
Handle screw	Steel
Compression nut	Brass
Compression cone	Brass

### GATE VALVES

Component	K416GM, K416GMLS
Body	Gunmetal
Bonnet	Gunmetal
Stem	Gunmetal
Gland	Brass
Gland Nuts	Brass
Packaging flange and bolts	Gunmetal
Handwheel	Aluminium
Nameplate	Aluminium
Handle screw	Steel
Compression nut	Brass
Compression cone	Brass

### QUARTER TURN BALL VALVES

Component	PB300, PB300T
Body	Forged brass, chrome plated
End piece	Forged brass, chrome plated
Ball	Brass, chrome plated
Stem	Brass bar
Seats	PTFE (Teflon)
Stem 'O' ring	Viton
Lever handle	High temperature PVC insulated zinc plated steel
Nut (self locking)	Zinc plated steel
Tee handle	Aluminium, painted
Security screws	Nickel plated brass
Compression nut	Forged brass, chrome plated
Compression cone	Brass

### QUARTER TURN BALL VALVES

Component	PB350, PB350T, PB350LS, PB350EL
Body	DZR brass
Ball	Brass, chrome plated
Stem	Brass
Stem 'O' ring	Viton
Seat rings	PTFE (Teflon)
Lever handle	Steel
Lever nut self locking	Zinc plated steel
Tee handle	Aluminium, painted (PB550DR T)
Tee handle security screw	Nickel plated brass
Lockshield cap	Plastic
Lockshield	Brass
Lockshield security screw	Brass
Compression nut	Brass
Compression cone	Brass
Sleeve	Brass (EL)
Ext Stem	Brass (EL)
Fixing screw	Steel (EL)
Washer	Brass (EL)

### CHECK VALVES

Component	K424
Body	DZR brass
Non-return valve	Nylon
Circlip	Stainless steel
Washer	DZR brass
Compression nut	Brass
Compression ring	Brass

### CHECK VALVES

Component	K4424, K4424CP
Body	DZR brass, chrome plated
Check valve	Nylon
Test plug	DZR brass
Test plug seal 'O' ring	WRAS approved elastnorr
Circlip	Stainless steel
Washer	DZR Brass
Compression nut	Brass, chrome plated
Compression ring	Brass



### THERMOSTATIC MIXING VALVES

Component	PEG402, PEG402UA, PEG402UAX
Body	DZR brass, chrome plated
Head	DZR brass, chrome plated
Stem	Brass
'O' ring	EPDM
Wafer stainer	Stainless steel
Security screw	Nickel plated brass
Cap	Plastic
Non-return valves	Plastic
Union angle tee	Painted alloy
Union washers	Nylon
Body/inlet protection caps	Nylon
Compression nut	Brass
Compression cone	Brass

### GATE VALVES

Component	V950
Body	Ductile iron
Body seat ring	Gunmetal
Bonnet	Ductile iron
Bonnet gasket	EPDM
Stem	Stainless steel
Wedge	Ductile iron
Wedge trim	Gunmetal
Wedge nut	Gunmetal
Gland flange	Ductile iron
Gland	Ductile iron
Gland packing	Graphite non asbestos
Stuffing box	Ductile iron
Stuffing box gasket	Compressed graphite
Handwheel	Ductile iron

### GATE VALVES

Component	V951
Body	Cast iron
Bonnet	Cast Iron
Bonnet gasket	EPDM
Stem	Steel
Wedge	Cast iron
Wedge nut	Brass
Gland packing	Brass
Gland follower	Ductile iron
Packing	Graphite non asbestos
Stuffing box	Cast iron
Stuffing box gasket	Graphite non asbestos
Handwheel	Cast iron
Yoke joint	Cast iron
Yoke sleeve	Gunmetal

### BUTTERFLY VALVES

Component	V905, V905G, V906, V906G
Body	Cast iron
Shaft	Stainless steel
Disc	Stainless steel
Bushes up to 100mm	PTFE
Bushes up to 125mm	Gunmetal
'O' ring	EPDM
Liner	EPDM

### BUTTERFLY VALVES

Component	V907, V907G
Body	Cast iron
Shaft	Stainless steel
Disc	Stainless steel
Bushes up to 100mm	PTFE
Bushes up to 125mm	Gunmetal
'O' ring	EPDM
Liner	Nitrile

### BALLOMAX BALL VALVES

Component	PB1006, PB1005, PB1007
Body	Steel
Ball	Stainless Steel
Bottom	Steel
Cover disc	Steel
Key	Steel
Back up ring	Steel
Plan bearing	Steel bush with PTFE
Seeger circlip	Spring steel
Back up ring seat packing	PTFE
Spindle	Steel
Spindle guide	Steel
Spiral spring	Steel

### WATER HAMMER ARRESTOR

Component	PEG 62
Body	Brass
Diaphragm	Acetac Resin
Seals	NBR
Spring	Stainless Steel
Gasket	Non asbestos fibre



## 3.0 TECHNICAL DATA

# MATERIALS SPECIFICATION

### CHECK VALVES

Component	V909
Body	Cast iron
Hinge pin	Stainless steel
Disc	Stainless steel
Seat	NBR
Stop pin	Stainless steel
Pin retainers	Stainless steel
Plate	Stainless steel
Spring	Stainless steel
Washer	PTFE
Gasket	EPDM

### CHECK VALVES

Component	V914
Body	Cast iron
Body seating	Gunmetal
Disc	Cast iron
Disc assembly	Cast iron
Disk facing ring	Gunmetal
Disc nut	Brass
Cover	Cast iron
Cover gasket	Graphite non asbestos
Hinge pin	Stainless steel
Hinge pin plug	Brass
Hinge	Ductile iron
Stop pin	Stainless steel
Seat	EPDM
Seat ring	Gunmetal
Gasket	Asbestos free
Springs	Stainless steel

### STRAINER

Component	V912
Body	Cast iron
Cap	Cast iron
Cover	Cast iron
Seal	Fibre TesnitBA-U
Screen	Stainless steel
Gasket	Teflon/graphite
Plug	Brass





## MATERIALS SELECTION AVOIDING STRESS CORROSION CRACKING (SCC)

Pegler Yorkshire do not recommend the use of brass valves and fittings in chilled water applications.

SCC occurs occasionally in Brass valves and Compression fittings, where high levels of stress in the component combined with a corrosive environment can cause cracks to form and grow.

High stresses are most commonly introduced by over-tightening compression nuts and threaded connections and for this reason it is very important that joints are assembled exactly in accordance with the published instructions.

The most common corrosive environment for brass items contains ammonia, or ammoniacal compounds.

These can be found in cleaning fluids, refrigeration gases, sewage waste products, building materials, insulating materials (especially foams) and flame and smoke retardant treatments. In addition, the presence of moisture, particularly condensation, can further concentrate the corrosive effects of such an environment.

SCC can be avoided completely by selecting items made from copper or gunmetal. Where this is not feasible SCC can be avoided by ensuring joints are not over-tightened during assembly and are then isolated from a potentially corrosive environment by wrapping it in a vapour barrier or coating with impermeable paint.

## INSTALLATION

Unpack the valve.

Check that the valve is correct for its intended use.

Check that the flow paths are clear and that the threads are clean and free from debris.

## THREADED VALVES

Ensure that the valve is fully open during installation.

Fix the threaded pipe into a vice and apply sealing compound on to the male pipe threads.

Use sealing compounds that do not over pack the threads. Preferred materials are PTFE thread tape or suitable liquid/paste sealant.

Do not use hemp.

Screw the valve on to the pipe.

**Use the spanner flats adjacent to the pipe joint being made. Do not use the flats at the opposite end of the valve.**

**Ensure that good quality, close fitting tools are used.**

**Avoid tightening to such an extent that the female end becomes permanently deformed.**

**Valves must not be over-tightened.**

Use suitable hangers close to both ends of the valve in order to remove stresses transmitted by the pipe.

## COMPRESSION END VALVES

The range is designed for use with copper tube to BS EN 1057:1996 (formerly BS 2871:Part 1), BS 2871:Part 2, or stainless steel tube to BS 4127:1994.

To make a joint:

Ensure that the fitting is the correct size for the pipe being used. Cut the pipe to length, making sure that the cut is square and the pipe is not deformed. Remove any burrs from the cut ends.

EITHER

Insert the pipe into the fitting without removing the cone, ensuring that the cone is in the correct position and that the pipe makes firm contact with the stop in the body of the valve.

OR

Unscrew the cap nut and cone from the fitting. Slide the cap nut and cone onto the pipe and insert the pipe into the fitting as far as the stop.

In both cases, tighten the cap nut onto the valve until the pipe cannot be rotated by hand. A drop of light machine oil on the threads will facilitate tightening - particularly on the larger size valves.

- + Over tightening will not produce a better joint, and may lead to problems in service
- + Jointing compounds or sealants are not necessary with Pegler Yorkshire compression ended valves; the use of these materials could impair the efficiency of the joint and may contravene water regulations
- + **Use the spanner flats on the compression nuts adjacent to the joint being made. Do not use the flats at the opposite end of the valve**
- + **Ensure that good quality close fitting tools are used**
- + **Avoid tightening to such an extent that the compression nuts become permanently deformed**
- + **Valve compression nuts must not be over tightened**
- + Cap nuts are made from brass
- + The valve should be operated from fully open to fully closed to test that it has been correctly installed
- + Make sure that a ball valve is fully open during installation.



## 3.0 TECHNICAL DATA

# PRESSURE EQUIPMENT DIRECTIVE

### THE PRESSURE EQUIPMENT DIRECTIVE 2014/68/EU & CE MARKING

The Pressure Equipment Regulations 1999 (SI 1999/2001) have now been introduced into United Kingdom law. Valves with a maximum allowable pressure greater than 0.5 bar are covered by these new Regulations. Valves are categorised according to their maximum working pressure, size and rising level of hazard. The level of hazard varies according to the fluid being carried. Fluids are classified as Group 1, dangerous fluids or Group 2, all other fluids including steam. The categories designated are SEP (sound engineering practice). Valves up to and including 25mm (1") are designated SEP regardless of the fluid group. Those identified as having increased hazard are categorised as I, II, III or IV. All valves designated as SEP do not bear the CE mark nor require a Declaration of Conformity. Categories I, II, III or IV carry the CE mark and require a Declaration of Conformity. Valves classified from the piping chart would not be included in Category IV.

### VALVE SELECTION

#### Selection, storage and protection

Valves must be properly selected for their intended service conditions. Provided it is installed correctly and receives adequate preventative maintenance it should give years of trouble-free service. They must be compatible with the system design, pressure and temperature requirements and must be suitable for the fluids that they are intended to carry. Interactions between metals in the pipe system and the valve must be considered as part of the valve selection.

Valves should be stored off the ground in a clean, dry, indoor area. Where desiccant bags are included with the valve these should be changed after a period of 6 months.

Pegler valves are supplied in appropriate packing to give adequate protection from damage. Cast iron and steel valves may

also have end protection caps.

When Pegler valves are fitted with pressure equipment or assemblies, suitable protective devices may be required.

### PRESSURE AND TEMPERATURE RATING

Valves must be installed in a piping system whose normal pressure and temperature does not exceed the stated rating of the valve. The maximum allowable pressure in valves as specified in the standards is for non-shock conditions. Water hammer and impact should also be avoided.

If system testing will subject the valve to pressures in excess of the working pressure rating, this should be within the 'shell test pressure for the body' to a maximum of 1.5 times the PN rating and conducted with the valve fully opened.

It may be hazardous to use these valves outside of their specified pressure and temperature limitations and also when not used for the correct application.

### LOCATION/END-OF-LINE SERVICE

To ensure ease of operation, adjustment, maintenance and repair, valve siting should be decided during the system design phase. To prevent imposing strain on the valve seat, pipe work and valves they must be adequately supported.

Where valves are installed for end-of-line service a blanking plug must be fitted to the downstream end of the valve. Pegler Ball, Globe, Check, Flanged Gate and Butterfly valves are not suitable for end-of-line service.

### PRE-INSTALLATION

#### Health & Safety

Before starting work on any installation a risk assessment must be made to consider the possibility of operational limits being exceeded and reduction or elimination of any potential hazards.

1. Protective clothing and safety equipment must be utilised as appropriate to the hazard presented

by the nature of the process to which the valve is being installed or maintained.

2. Before installing or removing a valve the pipeline circulating pumps (when fitted) must be turned off. The pipeline must be depressurised, drained and vented. Valves must be fully opened to ensure release of any pipeline or valve pressure.
3. Fitters must be trained in manual and mechanical handling to enable them to safely lift and install Pegler valves.
4. The valve selected must be suitable for the required service conditions. The pressure and temperature limitations are indicated on the valve nameplate, body or data plate. These must not be exceeded.
5. Valve seats, seals and internal components can be damaged by system debris. Protective devices may need to be fitted and system flushing may be required.
6. Any flushing fluid used to clean the pipeline must not cause any damage to the valve and its components.
7. Pegler valves must not be misused by lifting them by their hand wheels, levers or stems.
8. Pegler valves are not suitable for fatigue loading, creep conditions, fire testing, fire hazard environment, corrosive or erosive service, or for carrying fluids containing abrasive solids. There is no allowance for corrosion in the design of these valves. Designs for this valve do not allow for decomposition of unstable fluids and must not be used where this could occur.
9. Pegler valves are not designed to withstand the effects of fire, wind, earthquakes and traffic.
10. All Health and Safety Rules must be followed when installing and maintaining valves.



## INSTALLATION

Unpack the valve and check that the flow paths and valve connections are clean and free from debris. Check the body markings and nameplate to ensure that the correct valve has been selected for installation.

### Gate valves

May be fixed in 'Vertical pipe work with stem horizontal' or 'Horizontal pipe work with stem vertical and upright'. Make sure that a gate valve is fully closed during installation.

Fitting a gate valve in the open position may cause twisting and the gate and seating may not mate properly. The valve should be operated from fully open to fully closed to test that it has been correctly installed.

The valve should not be installed in horizontal pipe work with stem horizontal because full closure may be impeded by an accumulation of system debris. Pegler Valves are manufactured to exacting standards and, therefore, should not be subjected to misuse. Gate valves in cast iron may be fitted with geared handle mechanisms with handwheel rotation for opening and closing.

### Globe valves

Globe valves should be installed with the stems in a vertical position where possible. These valves perform better when there is a pressure under the valve's disk.

### Gate valves and ball valves

These valves perform best when they are installed in an upright position. The direction of flow through these valves is not important. They are fitted when the valve is in an open position.

### Horizontal check valves

Each valve body will have a directional flow arrow and this should be followed. In operation the seats will close when there is enough back flow to close off the flow and secure a seal.

Horizontal lift check valves must be installed in a level horizontal position to

allow the internal valve parts to rise and fall freely according to the pressure of fluid flowing through the valve.

### Swing check valves

Each swing check is marked with a directional flow arrow. This should be observed and fitted in the pipe work accordingly. A swing check valve may be fitted horizontally or vertically, ensuring that the arrow is pointing upwards if fitted vertically. They should not be used in close proximity to equipment with 'pulsating flow'.

### Wafer check valves

Wafer pattern swing check valves should be positioned with the hinge pin in a horizontal installation.

Directional arrows indicate the flow direction required to operate the valve.

The valve should be sited between two matching flanges with gaskets positioned on the valve faces. Bolts of the appropriate type and size should be used to complete the assembly, using nuts to make the joints water tight.

### Butterfly valves

Butterfly valves should be assembled with the valve in a closed position to avoid damage to the disc edge. Butterfly valves are assembled between two mating flanges with the extended portion of the liner acting as a gasket. The flanges with the butterfly valve can be secured with the appropriate bolts and nuts to achieve a successful joint.

### Thread joints

Confirm that the pipe threading length is correct to avoid excessive penetration of the pipe into the valve that would otherwise cause damage. Care should be taken to apply jointing compound to the pipe only and not in the valve threads. Surplus compound will then be forced outwards and will not enter the valve. Over use of compound can lead to valve failure on the body ends. Threads should be engaged correctly when tightening the valve onto the pipe. The wrench should always be fitted on the body end

adjacent to the joint being made. Severe damage can occur to stems, valves and seats by the use of hand wheels or levers larger than those originally supplied by the manufacturer, and by wheel keys.

The Pegler range of valves now includes both push and press ends suitable for different tube connections. Installation guidance is provided with the product or available on the Pegler Yorkshire website.

Any electrical component e.g. actuators, limit switches must be explosion proof and comply with the ATEX Directive and Standards as listed in BS EN 1127-1 clause 6.4.5.

## OPERATION

### Gate valves

To open – an anti-clockwise rotation of the hand wheel will open the valve. When it will go no further return the hand wheel clockwise ½ turn. To close the valve a clockwise rotation of the hand wheel will close the valve. Closure will be confirmed when the handle can be turned no further.

**Caution:** Service applications with extremes of temperature may cause the wedge to become tight in the valve. The valve may become stiff to operate in these circumstances. Suitable hand protection should be worn when operating valves used in extreme temperature applications. The valve should only be used in the fully open or fully closed position. Gate valves are not suitable for regulating and throttling service.

### Globe valves

To open – an anti-clockwise rotation of the hand wheel will open the valve. When it will go no further return the hand wheel clockwise ½ turn. To close the valve a clockwise rotation of the hand wheel will close the valve. Closure will be confirmed when the handle can be turned no further.

**Caution:** Suitable hand protection should be worn when operating valves used in extreme temperature applications. Globe valves are suitable for regulating and throttling service.





## 3.0 TECHNICAL DATA

# PRESSURE EQUIPMENT DIRECTIVE

### Check valves

The horizontal/vertical pattern check valves operate according to the flow within the pipeline and there is no external method of operation.

All check valves are self acting with some patterns having spring assisted closure.

### Butterfly valves

Butterfly valves are opened by depressing the spring loaded handle, rotating the spindle through 90° from closed to open position. Cast iron commissioning and double regulating have a 'memory stop' feature to enable a closed valve to return to a pre-set position.

### Ball valves

**PB LEVER HANDLE** To open - turn the lever 90° so that it is in line with the pipe run in which it is installed. To close - turn the lever 90° so that it is across the line of the pipe in which it is installed. Full opening and closing is completed when a full 90° is achieved and the lever is firmly set against the stop on the valve body.

**PB LOCKSHIELD BALL VALVES** To open - remove dust cap. Select the appropriate cross key. Turn the key through 90° so that it is in line with the pipe run. To close- turn the key through 90° so that it is across the line of the pipe in which it is installed. Full opening and closing is complete when a 90° is achieved and the key rotation is firmly set against the stop on the valve body. Replace the dust cap.

**PB T** Models have lockable handles for use in both open and closed positions. In the fully open position the T handle is in line at 90° with the pipe work. To lock the valve in the closed position a hexagon key of the appropriate size can be used to remove the securing screw. The T handle can then be lifted from the valve. This should then be rotated through 180° and refitted on to the valve spindle ensuring the handle slot engages on to the body lug. Insert the securing screw and re-tighten with the hexagon key.

**PB SEK** kits are available giving an extended spindle mechanism that lifts the lever away from the body and is

particularly useful when pipe insulation is being used. This version is only available with a standard lever handle.

**Caution:** Service applications with extremes of temperature may cause the ball to become tight in the valve. The valve may become stiff to operate in these circumstances. Suitable hand protection should be worn when operating valves used in extreme temperature applications. The valve should only be used in the fully open or fully closed position. Ball valves are not suitable for regulating or throttling applications.

### MAINTENANCE

A regular maintenance program is the most efficient method of ensuring longer term operational efficiency of the selected valve. Such a program would need to include a risk assessment and a planned procedure of how the maintenance will be carried out. The possibility of operational limits being exceeded and the potential hazards ensuing must be considered as part of this assessment. This should be implemented to include visual checks on the valve's condition and any development of unforeseen conditions, which could lead to failure. The correct fitting tools and equipment should be used for valve maintenance work. Separate means of draining the pipe work must be provided when carrying out any maintenance to valves. Where there may be any system debris this should be collected and/or filtered by installation of the appropriate protective device.

**Gland Adjustment** - The gland may need adjustment during installation and then periodically thereafter to maintain a stem gland seal.

**NOTE:** It is recommended that within the 1st year the gland be inspected at 3 monthly intervals to check for gland leakage.

**Gland Replacement** - Under normal working conditions Pegler gate and globe valves do not normally require any maintenance, however, in the event

of maintenance being necessary, the following procedure should be followed:

Before starting work, de-pressurise the system, turn off any circulating pumps. Slacken the hand wheel nut and remove the nut, nameplate and hand wheel. Remove the gland nut and gland ring. Using a suitable tool, lift out the existing packing and make sure the stem and stuffing box are clean & free from debris. Care must be taken not to damage the valve stem.

**Fit a replacement Pegler packing gland into the stuffing box and push down firmly.**

Re-assemble the gland ring and gland nut.

Re-attach the handwheel, nameplate and nut.

Tighten the gland nut and confirm stem resistance while operating the valve. Once line pressure is re-established a check for leak tightness should be made, further adjust the gland nut as required necessary to achieve a satisfactory seal.

**NB. Permanent removal of the gland nut and/or the Data Plate will invalidate the CE compliance of this valve. Pegler Ball valves and Check valves are generally NOT suitable for being maintained.**

### 1029 Renewable Valve Disc Replacement.

Before starting work de-pressurise the system, turn off any circulating pumps, and ensure the valve is empty of fluid. Using a suitable wrench remove the complete bonnet assembly from the valve. Care should be taken to ensure the pipework is held securely during this process so that there is no distortion to the valve threads. Any damage to the threads could lead to valve failure. Slacken and remove disc nut and disc.

Assess damage to valve seat replacing the whole valve if necessary.

The valve disc can be replaced with an equivalent size disc and type as



appropriate. Re-attach a replacement disc and disc nut. Re-assemble the bonnet in to the valve body, checking for damage. Ensure the valve bonnet is joined securely to body and will not leak.

**N.B. The 1029 Globe valves have non-metallic PTFE valve discs.**

**Installation, operating & maintenance instructions are available from the Sales Office.** Pegler recommended spares must be used. Refer to Pegler Technical Department for further information.

#### **PRODUCT LIFE SPAN**

When a valve is properly selected for its service conditions it should give years of trouble-free service provided it is installed correctly and receives adequate preventative maintenance. By not considering the compatibility of the system design and the pressure and temperature requirements the life expectancy of the valves can be adversely affected and valve failure may occur. The nature of the fluid being carried through the valve could also affect the valve performance as this could lead to premature valve failure.

There may also be interactions between metals in the pipe system and the valve which need to be considered. Appropriate flushing and cleaning of the pipe work installation should take place when commissioning the system as this would help extend the valve life.

Reference Material: Pegler Valves Package Brochure. A Technical File is held at Doncaster as part of the requirements for compliance to the European Pressure Equipment Directive (PED 97/23 EC).



## 3.0 TECHNICAL DATA

# PRESSURE EQUIPMENT DIRECTIVE

### QUARTER TURN BALL VALVES

PED CATEGORISATION												
SIZES												
Product	DN8 1/4"	DN10 3/8"	15mm DN15 1/4"	18mm DN15 1/2"	22mm DN20 3/4"	28mm DN25 1"	35mm DN32 1 1/4"	42mm DN40 1 1/2"	54mm DN50 2"	DN65 2 1/2"	DN80 3"	DN100 4"
PT500, XT500, PT550, PT550EL, XT550, XT550EL, PS500, PSU500, PSU500EL, PS550, PS550EL, PSU550, PSU550EL			SEP	SEP	SEP	SEP	SEP	SEP	SEP			
PT500T, PT550T, PS500T, PS550T			SEP	SEP	SEP	SEP						
TX300			SEP		SEP							
*PB700, *PB500 (yellow), *PB300, *PB300T	SEP	SEP	SEP	SEP	SEP	SEP	CAT I	CAT I	CAT I	CAT I	CAT I	CAT I
PB700T	SEP	SEP	SEP	SEP	SEP	SEP						
PB500 (red)	SEP	SEP	SEP	SEP	SEP	SEP	SEP	SEP	SEP	SEP	SEP	SEP
PB500MF		SEP		SEP	SEP	SEP	SEP	SEP	SEP			
PB500MF		SEP		SEP	SEP	SEP						
PB500DC, PB550DR T				SEP	SEP	SEP						
PB500T		SEP	SEP	SEP	SEP	SEP						
PB500EL, PB550DR, PB550DR LS, PB550EL				SEP	SEP	SEP	SEP	SEP	SEP			
PB100				SEP	SEP	SEP	SEP	SEP	SEP	SEP	SEP	SEP
1111BV						SEP	SEP	SEP	SEP			
PB560, PB560T					SEP							
PB350, PB350LS, PB350EL			SEP		SEP	SEP	SEP	SEP	SEP			
PB350T			SEP		SEP	SEP						

\*CE Marked, compliant with Construction Products Directive (1/4" - 2", 15mm - 54mm)

### GATE VALVES

PED CATEGORISATION																	
SIZES																	
Product	DN8 1/4"	DN10 3/8"	15mm DN15 1/2"	18mm DN15 1/2"	22mm DN20 3/4"	28mm DN25 1"	35mm DN32 1 1/4"	42mm DN40 1 1/2"	54mm DN50 2"	67mm DN65 2 1/2"	76mm DN80 3"	DN100 4"	DN125 5"	DN150 6"	DN200 8"	DN250 10"	DN300 12"
PT1070/125, PT1070/125LS, PT1068, PT1068LS, XT1068, XT1068LS, PS1070/125, PS1070/125LS, PSU1070/125, PSU1070/125LS, PS1068, PS1068LS, PSU1068, PSU1068LS, PS1078, PS1078LS, PSU1078, PSU1078LS			SEP	SEP	SEP	SEP	SEP	SEP	SEP								
1072, 1070/125LS, 1065, 1068LS, 1078, 1078LS			SEP		SEP	SEP	SEP	SEP	SEP								
1070/125, 1068			SEP		SEP	SEP	SEP	SEP	SEP	SEP	SEP						
63, K416GM, K416GMLS			SEP		SEP	SEP	SEP	SEP	SEP								
K416GM									SEP	SEP							
63LS, K416, K416LS			SEP		SEP	SEP											
V950									SEP	SEP	SEP	SEP	SEP	SEP	SEP	SEP	SEP
V951									SEP	SEP	SEP	SEP	SEP	SEP	SEP	SEP	SEP



## CHECK VALVES

PED CATEGORISATION																	
SIZES																	
Product	DN8 1/4"	DN10 3/8"	15mm DN15 1/2"	18mm DN15 1/2"	22mm DN20 3/4"	28mm DN25 1"	35mm DN32 1 1/4"	42mm DN40 1 1/2"	54mm DN50 2"	DN65 2 1/2"	DN80 3"	DN100 4"	DN125 5"	DN150 6"	DN200 8"	DN250 10"	DN300 12"
PT1060A, PS1060A, PSU1060A			SEP	SEP	SEP	SEP	SEP	SEP	SEP	SEP	SEP	SEP					
PS4426, PSU4426			SEP	SEP	SEP	SEP	SEP	SEP	SEP								
1063, 1064			SEP		SEP	SEP	SEP	SEP	SEP	SEP	SEP	SEP					
1062			SEP		SEP	SEP											
1039, K4426			SEP		SEP	SEP	SEP	SEP	SEP								
K424			SEP		SEP	SEP											
V909, V914										SEP	SEP	SEP	SEP	SEP	SEP	SEP	SEP

## STRAINERS

PED CATEGORISATION														
SIZES														
Product	15/18mm DN15 1/2"	22mm DN20 3/4"	28mm DN25 1"	35mm DN32 1 1/4"	42mm DN40 1 1/2"	54mm DN50 2"	DN65 2 1/2"	DN80 3"	DN100 4"	DN125 5"	DN150 6"	DN200 8"	DN250 10"	DN300 12"
PT913, PS913, PSU913, V913	SEP	SEP	SEP	SEP	SEP	SEP								
1059PT	SEP	SEP	SEP	SEP	SEP	SEP	SEP	SEP	SEP					
V912							SEP	SEP	SEP	SEP	SEP	SEP	SEP	SEP

## PRESSURE REDUCING VALVE

PED CATEGORISATION											
SIZES											
Product	15mm DN15 1/2"	18mm DN15 1/2"	22mm DN20 3/4"	28mm DN25 1"	35mm DN32 1 1/4"	42mm DN40 1 1/2"	54mm DN50 2"	DN65 2 1/2"	DN80 3"	DN100 4"	
PT5 PRV	SEP										
PS4 PRV	SEP	SEP	SEP	SEP	SEP	SEP	SEP				
PRV4 PT	SEP		SEP	SEP	SEP	SEP	SEP	SEP	SEP	SEP	SEP

## HENCO MULTI-LAYER BALL VALVES

PED CATEGORISATION						
SIZES						
Product	DN15 16mm 1/2"	DN15 20mm 1/2"	DN20 26mm 3/4"	DN25 32mm 1"	DN32 40mm 1 1/4"	
MLH500, MLH500EL, MLH550, MLH550EL	SEP	SEP	SEP	SEP		
MLC500, MLC500EL, MLC550, MLC550EL	SEP	SEP	SEP	SEP	SEP	



## 3.0 TECHNICAL DATA

# PRESSURE EQUIPMENT DIRECTIVE

### HENCO MULTI-LAYER GATE VALVES

PED CATEGORISATION					
SIZES					
Product	DN15 16mm 1/2"	DN15 20mm 1/2"	DN20 26mm 3/4"	DN25 32mm 1"	DN32 40mm 1 1/4"
MLH1070/125, MLH1070/125LS, MLH1068, MLH1068LS, MLH1078, MLH1078LS	SEP	SEP	SEP	SEP	
MLC1070/125, MLC1070/125LS, MLC1068, MLC1068LS, MLC1078, MLC1078LS	SEP	SEP	SEP	SEP	SEP

### HENCO MULTI-LAYER CHECK VALVES

PED CATEGORISATION					
SIZES					
Product	DN15 16mm 1/2"	DN15 20mm 1/2"	DN20 26mm 3/4"	DN25 32mm 1"	DN32 40mm 1 1/4"
MLH4426	SEP	SEP	SEP	SEP	
MLC4426	SEP	SEP	SEP	SEP	SEP

### HENCO MULTI-LAYER STRAINERS

PED CATEGORISATION					
SIZES					
Product	DN15 16mm 1/2"	DN15 20mm 1/2"	DN20 26mm 3/4"	DN25 32mm 1"	DN32 40mm 1 1/4"
MLH913	SEP	SEP	SEP	SEP	
MLC913	SEP	SEP	SEP	SEP	SEP

### BIBTAPS

PED CATEGORISATION		
SIZES		
Product	1/2"	3/4"
PB50HU, PB52HU	SEP	SEP
PB50, PB50AT	SEP	

### WATER HAMMER ARRESTOR

PED CATEGORISATION	
SIZES	
Product	1/2"
PEG62WHA	SEP





### BALLOMAX BALL VALVES

PED CATEGORISATION																	
SIZES																	
Product	DN15 1/2"	DN20 3/4"	DN25 1"	DN32 1 1/4"	DN40 1 1/2"	DN50 2"	DN65 2 1/2"	DN80 3"	DN100 4"	DN125 5"	DN150 6"	DN200 8"	DN250 10"	DN300 12"	DN350 14"	DN400 16"	DN500 20"
PB1000, PB1001, PB1002	Cat 111	Cat 111	Cat 111	Cat 111	Cat 111	Cat 111											
PB1004										Cat 111	Cat 111	Cat 111	Cat 111	Cat 111	Cat 111	Cat 111	Cat 111
PB1003								Cat 111	Cat 111	Cat 111							
PB1007						Cat 111	Cat 111	Cat 111	Cat 111	Cat 111	Cat 111	Cat 111	Cat 111				

### GLOBE VALVES

PED CATEGORISATION									
SIZES									
Product	DN8 1/4"	DN10 3/8"	DN15 1/2"	DN20 3/4"	DN25 1"	DN32 1 1/4"	DN40 1 1/2"	DN50 2"	
1029	SEP	SEP	SEP	SEP	SEP	CAT 1	CAT 1	CAT 1	
1031			SEP	SEP	SEP	SEP	SEP	SEP	

### DRAIN VALVES

PED CATEGORISATION			
SIZES			
Product	DN15 1/2"	DN20 3/4"	DN25 1"
PB60HU, 1832	SEP	SEP	SEP

### BUTTERFLY VALVES

PED CATEGORISATION									
SIZES									
Product	DN65 2 1/2"	DN80 3"	DN100 4"	DN125 5"	DN150 6"	DN200 8"	DN250 10"	DN300 12"	DN350 14"
V905, V906, V907				SEP	SEP	SEP			
V905G							SEP	SEP	SEP
V906G, V907G							SEP	SEP	

### BALLOMAX BALL VALVES

PED CATEGORISATION																	
SIZES																	
Product	DN15 1/2"	DN20 3/4"	DN25 1"	DN32 1 1/4"	DN40 1 1/2"	DN50 2"	DN65 2 1/2"	DN80 3"	DN100 4"	DN125 5"	DN150 6"	DN200 8"	DN250 10"	DN300 12"	DN350 14"	DN400 16"	DN500 20"
PB1006							Cat 111	Cat 111	Cat 111	Cat 111	Cat 111	Cat 111	Cat 111	Cat 111	Cat 111	Cat 111	Cat 111
PB1005	Cat 111	Cat 111	Cat 111	Cat 111	Cat 111	Cat 111											



## 3.0 TECHNICAL DATA

### FLANGE TABLES

**PN16 BS EN 1092-1:1997 DN65-DN300 - V907, V907G, V951**

	FLANGE DIAMETER (mm)	PITCH CIRCLE DIAMETER (mm)	NO. OF BOLTS	BOLT DIAMETER (mm)	HOLE DIAMETER (mm)	RAISED FACE DIAMETER (mm)	RAISED FACE HEIGHT (mm)	THICKNESS OF FLANGE (mm)
DN65	160	130	4	M12	14			16
DN80	190	150	4	M16	19			18
DN100	210	170	4	M16	19			18
DN125	240	200	8	M16	19			20
DN150	265	225	8	M16	19			20
DN200	320	280	8	M16	19			22
DN250	375	335	12	M16	19			24
DN300	440	395	12	M20	23			24

**PN16 BS EN 1092-1:2007 DN65-DN300 - 900XSS, 900XSL, 901XS, V905, V905G, V906, V906G**

	FLANGE DIAMETER (mm)	PITCH CIRCLE DIAMETER (mm)	NO. OF BOLTS	BOLT DIAMETER (mm)	HOLE DIAMETER (mm)	RAISED FACE DIAMETER (mm)	RAISED FACE HEIGHT (mm)	THICKNESS OF FLANGE (mm)
DN65	185	145	4 (2)	M16	19	-	-	20
DN80	200	160	8	M16	19	-	-	22
DN100	220	180	8	M16	19	-	-	24
DN125	250	210	8	M16	19	-	-	26
DN150	285	240	8	M20	23	-	-	26
DN200	340	295	12	M20	23	-	-	30
DN250	405 (2)	355	12	M24	28	-	-	32
DN300	405 (2)	410	12	M24	28	-	-	32

**PN16 BS EN 1092-1:1997 DN65-DN300 - V914, V912, V950, V952**

	FLANGE DIAMETER (mm)	PITCH CIRCLE DIAMETER (mm)	NO. OF BOLTS	BOLT DIAMETER (mm)	HOLE DIAMETER (mm)	RAISED FACE DIAMETER (mm)	RAISED FACE HEIGHT (mm)	THICKNESS OF FLANGE (mm)
DN65	185	145	4 (2)	M16	19	-	-	20
DN80	200	160	8	M16	19	-	-	22
DN100	220	180	8	M16	19	-	-	24
DN125	250	210	8	M16	19	-	-	26
DN150	285	240	8	M20	23	-	-	26
DN200	340	295	12	M20	23	-	-	30
DN250	405 (2)	355	12	M24	28	-	-	32
DN300	460 (2)	410	12	M24	28	-	-	32



CONNECT + CONTROL

**PN16 DIN2633 DN65-DN500 – PB1006**

	FLANGE DIAMETER (mm)	PITCH CIRCLE DIAMETER (mm)	NO. OF BOLTS	BOLT DIAMETER (mm)	HOLE DIAMETER (mm)	RAISED FACE DIAMETER (mm)	RAISED FACE HEIGHT (mm)	THICKNESS OF FLANGE (mm)
DN65	185	145	4 (2)	M16	18	122	3	14
DN80	200	160	8	M16	18	138	2	20
DN100	220	180	8	M16	18	158	2	20
DN125	250	210	8	M16	18	188	2	22
DN150	285	240	8	M20	22	212	2	22
DN200	340	295	12	M20	22	268	2	24
DN250	405 (2)	355	12	M24	26	320	2	26
DN300	460 (2)	410	12	M24	26	370	2	28
DN350	520	470	16	M24	26	438	2	30
DN400	580	525	16	M27	30	490	2	32
DN500	715	650	20	M30	33	610	2	44 (2)

**PN40 DIN2633 DN15-DN50 – PB1005**

	FLANGE DIAMETER (mm)	PITCH CIRCLE DIAMETER (mm)	NO. OF BOLTS	BOLT DIAMETER (mm)	HOLE DIAMETER (mm)	RAISED FACE DIAMETER (mm)	RAISED FACE HEIGHT (mm)	THICKNESS OF FLANGE (mm)
DN15	95	65	4	M12	14	45	2	16
DN20	105	75	4	M12	14	58	2	18
DN25	115	85	4	M12	14	68	2	18
DN32	140	100	4	M16	18	78	2	18
DN40	150	110	4	M16	18	88	2	18
DN50	165	125	4	M16	18	102	2	20



## 3.0 COMMERCIAL VALVE SOLUTIONS CONNECTION INSTRUCTIONS



### TECTITE PUSH-FIT CONNECTIONS FOR JOINTS 15mm TO 54mm

1. Always cut the tube square, using a rotary tube cutter whenever possible.

If you are using PEX or PB pipe cut the pipe using pipe shears. When using plastic coated carbon steel tube remove the coating using the S115 stripping tool.

Deburr the tube end, both internally and externally to create a 1mm chamfer on the outside of the tube.

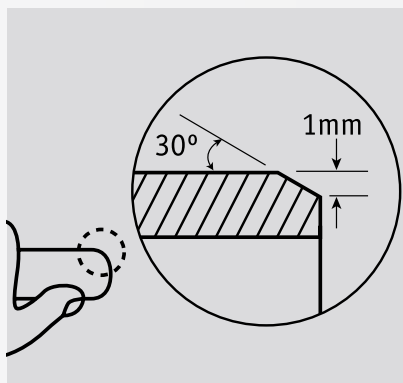

Check the tube ends are free from damage and clean, wiping away any swarf to avoid damaging the 'O' ring on tube insertion. Tube end must also be free from stickers, tape and adhesive residues.

Where using PEX or PB you must use always insert a support liner ensuring it is the correct liner as specified by the pipe manufacturer. If the pipe has been used on previous installations you will need to cut it back to behind the teeth or score marks.

Mark the socket depth with a marker.

FITTING SOCKET DEPTHS FOR TECTITE		
Size	Sprint & Advance*	Copper/Stainless/Carbon
10mm	15mm	23mm
15mm	18mm	23mm
18mm		23mm
22mm	19mm	27mm
28mm	20mm	31mm
35mm	31mm*	57mm
42mm	32mm*	62mm
54mm	37mm*	68mm

For chrome plated copper tube you must scribe the tube using the correct Tectite Scribing tool.

Select the correct type and size of fitting for pipework.

### PUSH-FIT SOLUTIONS

The fitting should be kept in its bag until point of use to protect the 'O' ring.

2. Inspect the fitting ensuring that the grab rings/'O' rings have not been contaminated with grit or debits. Insert the pipe into the mouth of the fitting to rest against the grab ring.
3. Push the tube firmly with a slight twisting action until it reaches the tube stop.
4. Ensure the depth insertion mark corresponds with the mouth of the fitting and then pull firmly on the tube to ensure the fitting is secure.

### 35mm TO 54mm SIZES

The first thing to consider when it comes to installation of 35mm to 54mm fittings is whether you plan to demount any fittings in the system on a regular basis. If you do, then we recommend you replace the standard end cap with the appropriately sized TDX demounting end cap.

To ensure the fittings stay clean and the 'O' ring is protected from damage, never remove the fitting from its packaging until immediately prior to installation.

5. Insert the tube through the end cap to rest against the grab ring.
6. Now push the tube firmly with a slight twisting action until it reaches the tube stop.
7. Ensure the depth insertion mark corresponds with the mouth of the fitting, then pull firmly on the tube to ensure that the fitting is secure.

**NOTE:** We recommend all systems are thoroughly pressure tested to 1.5 times working pressure before the hand-over to the customer.

**For full installation details refer to Tectite data book.**



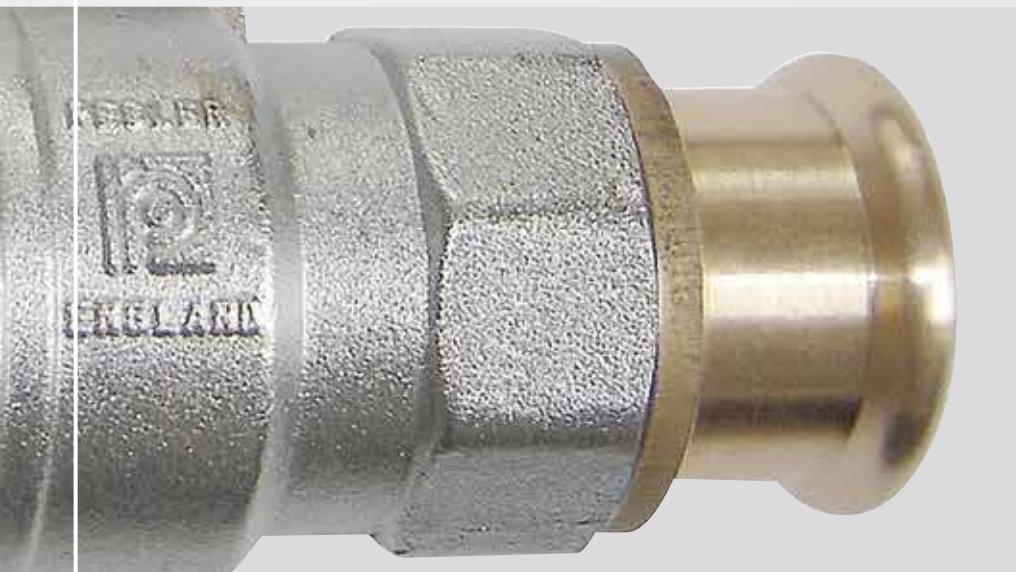

### XPRESS PRESS-FIT CONNECTIONS

1. Select the correct size of tube and fitting for the job. Ensure that both are clean, in good condition and free from damage and imperfections.
2. Cut the tube square using a rotary tube cutter whenever possible. If a hacksaw is used to cut the tube, a fine toothed blade should be used, care must be taken to ensure that the tube is cut square and properly de-burred. When using plastic coated carbon steel tube, the coating must be removed to the exact socket depth of the fitting and the tube deburred.
3. The tube end should then be wiped clean of all swarf and debris, to avoid damage to the 'O' ring upon tube insertion.
4. To make a perfect joint, the tube must be fully inserted into the fitting until it meets the tube stop.
5. Ensure that the 'O' ring is seated correctly within the fitting socket.

### JOINTING

1. Assemble the joint, ensuring that the tube is inserted into the connection until it meets the tube stop. The mark on the tube made earlier should be used as a guide to ensure this is the case. For plastic coated carbon steel tube, the mouth of the fitting should be in contact with the plastic coating. Only when the tube reaches the tube stop should the pressing operation be undertaken.
2. With the correctly sized jaws inserted into the press tool, place them over the bead at the mouth of the fitting. A 90° angle between tube and jaws must be maintained to ensure a sound joint is made.
3. Depressing the trigger or button will commence the compression cycle of the tool, which is complete when the jaws fully enclose the mouth of the fitting. The jaws should then be released from around the fitting. Please refer to the tool manufacturers instructions for further detailed information.

### SPACING

In order to make a joint correctly sufficient clearance around each fitting must be left to allow press-fit jaws to be attached without hindrance.

For full installation details refer to XPress data book.

FITTING SOCKET DEPTHS	
Size	Copper/Stainless/Carbon
15mm	20mm
18mm	20mm
22mm	21mm
28mm	23mm
35mm	26mm
42mm	30mm
54mm	35mm



## 3.0 COMMERCIAL VALVE SOLUTIONS

# CONNECTION INSTRUCTIONS

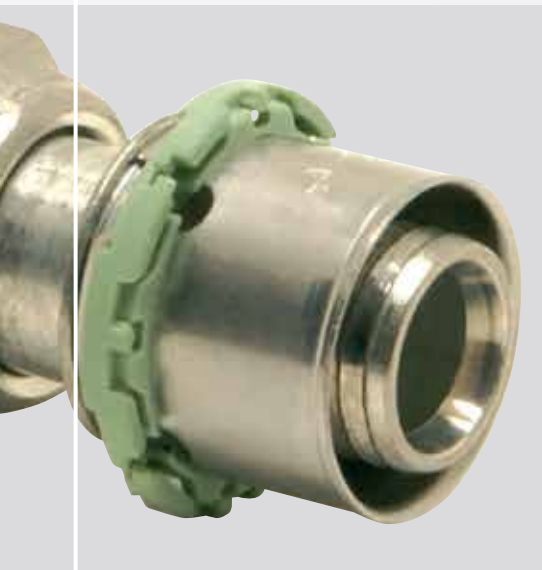

### HENCO BRASS PRESS-FIT CONNECTIONS

#### PIPE PREPARATION

When opening a coil of multi-layer pipe always use a SAFECUT cutter to open the packaging.

Never cut into the packaging with a sharp knife.

For pipe 16mm to 26mm, cut the pipe square using guillotine cutter (RSPRESS) or rotary tube cutter (RS32/RS63). It is vital to select a rotary tube cutter with a cutting wheel suitable for multi-layer pipe.

For pipe 32mm and above a rotary tube cutter must be used, (RS32/RS63) or (Rems Cento) it is vital to select a rotary tube cutter with a cutting wheel suitable for multi-layer pipe.

All sizes of pipe need calibrating, and chamfering after been cut. Insert the correct size of Kalispeed tool into the pipe and then rotate clockwise until a chamfer is created internally and externally on the pipe end.

Check the pipe end is free from swarf and has been fully chamfered.

#### JAWS SELECTION

To joint Henco Brass fittings you must use only the following jaw profiles:

- 16mm - 26mm TH profile jaws
- 32mm THL profile sling jaws
- 40mm and above TH profile jaws

#### JOINTING 16mm TO 32mm

The fittings should be kept in their bags until point of use to protect the 'O' ring.

Choose the correct size fitting for the pipe work.

Push the prepared end of pipe firmly into fitting with a slight twisting action, until the pipe is visible in the socket depth window.

It is important to allow sufficient clearance around each joint to allow the press-fit jaws or sling to be attached without hindrance and to provide sufficient access for the press tool.

Make the tool safe by isolating it from the power supply.

When using power tools great care must be taken at all times. Always follow the tool manufacturer's instructions.

Select the correct jaws for the joint being made checking that they are free from damage. Attach to the press tool and reconnect the power supply when ready.

Take care to correctly position the jaws over the fitting socket making sure the Visio control ring sits in the profile of the jaws.

Maintaining a 90° angle to ensure the integrity of the joint, and to protect you from kickback, where there is a risk of the machine moving sideways.

With the tool fully supported and not hanging from the pipework, and with your hands safely away from the jaws, run a complete pressing cycle. Making sure that the jaws fully close around the fitting socket.

Release the jaws from the fitting and inspect the joint, checking that it has been fully crimped and the pipe is still visible in the socket depth window.

#### JOINTING 40mm AND ABOVE

Select the correct size of fitting for the pipe work. Remove the protective cap.

Push the prepared end of pipe firmly into fitting with a slight twisting action, until the pipe is visible in the socket depth window.

It is important to allow sufficient clearance around each joint to allow the press-fit sling to be attached without hindrance and to provide sufficient access for the press tool.

Select the correct sling jaws for the joint being made, checking that they are free from damage.

Mount the sling jaws over the fitting so that the Visio control ring sits in the profile of the sling correctly, taking care not to trap your fingers in the sling.

Check that the pipe is still visible in the socket depth window.

When using power tools great care must be taken at all times. Always follow the tool manufacturer's instructions.

Make the tool safe by isolating it from the power supply.

Select the correct adaptor and attach it to the press tool following the instructions for the press-tool, and reconnect the power supply when complete.

Attach the adaptor to the sling jaw with the tool fully supported and maintaining a 90° angle to pipe work to protect you from kickback and to ensure the integrity of the joint.

With the tool fully supported and not hanging from the pipework, and with your hands safely away from the sling jaws, run a complete pressing cycle. Making sure that the sling fully close around the fitting socket.

Disconnect the adaptor and remove the sling jaw from the fitting.

Inspect the joint, checking that it has been fully crimped and the pipe is still visible in the socket depth window.





## HENCO PVDF PRESS-FIT MULTI-LAYER PIPE CONNECTIONS

### PIPE PREPARATION

When opening a coil of multi-layer pipe always use a SAFECUT cutter to open the packaging.

Never cut into the packaging with a sharp knife.

For pipe 16mm to 26mm, cut the pipe square using guillotine cutter (RSPRESS) or rotary

tube cutter (RS32/RS63). It is vital to select a rotary tube cutter with a cutting wheel suitable for multi-layer pipe.

For pipe 32mm and above a rotary tube cutter must be used, (RS32/RS63) or (Rems Cento) it is vital to select a rotary tube cutter with a cutting wheel suitable for multi-layer pipe.

All sizes of pipe need calibrating, and chamfering after been cut. Insert the correct size of Kalispeed tool into the pipe and then rotate clockwise until a chamfer is created internally and externally on the pipe end.

Check the pipe end is free from swarf and has been fully chamfered.

### JAWS SELECTION

To joint Henco PVDF fittings you must use the only the following jaw profiles:  
16mm - 26mm BE or TH profile jaws  
32mm and above BE profile jaws

### JOINTING

The fittings should be kept in their bags until point of use to protect the 'O' ring.

Choose the correct size fitting for the pipe work.

Push the prepared end of pipe firmly into fitting with a slight twisting action, until the pipe is visible in the socket depth window.

It is important to allow sufficient clearance around each joint to allow the press-fit jaws or sling to be attached without hindrance and to provide sufficient access for the press tool.

Make the tool safe by isolating it from the power supply.

When using power tools great care must be taken at all times. Always follow the tool manufacturer's instructions.

Select the correct jaws for the joint being made checking that they are free from damage. Attach to the press tool and reconnect the power supply when ready.

Take care to correctly position the jaws over the fitting socket making sure that the shoulder at the mouth of the fitting sits in the jaw profile.

Maintaining a 90° angle to ensure the integrity of the joint, and to protect you from kickback, where there is a risk of the machine moving sideways.

With the tool fully supported and not hanging from the pipework, and with your hands safely away from the jaws, run a complete pressing cycle. Making sure that the jaws fully close around the fitting socket.

Release the jaws from the fitting and inspect the joint, checking that it has been fully crimped and the pipe is still visible in the socket depth window.



### THREADED CONNECTIONS

Ensure that threads are prepared correctly to provide a good and long lasting service.

Pipe compound should be applied to pipe ends only and not directly into the valve.

Valves should not be over tightened with a wrench.

Ensure the pipe is threaded to the correct type and length. If the pipe is threaded too short a leak may occur. If the pipe is threaded too long then damage may be made to the valve.

Ensure that good quality tools are used to provide an accurate joint and therefore avoiding the risk of leaking.

Thread tape may be used and applied to the external of the pipe thread after the threads have been cleaned.

### JOINING THE VALVE AND PIPE

Fix the threaded pipe into a vice and then turn the valve on to the pipe.

A close fitting spanner should be applied to the valve hexagon/octagon flats being fixed. By tightening the valve onto the pipe in this way, the valve avoids being distorted with the consequential damage to internal parts.







## 3.0 COMMERCIAL VALVE SOLUTIONS

# CONNECTION INSTRUCTIONS



### COMPRESSION CONNECTIONS

1. Select the correct size of tube for the job. Ensure that it is clean, in good condition and free from damage and imperfections. If the tube is oval or damaged, use a re-rounding tool. Copper tube should be of half-hard (R250) or hard (R290) temper. Annealed soft temper tube (R220) can be used.
2. Cut the tube square using a rotary tube cutter wherever possible. If a hacksaw is used to cut the tube, a fine toothed blade should be used.
3. Remove any burr from the inside and outside of the tube ends using a fine toothed file or a S120 deburring tool from the XPress accessories range.

### CONNECTING COPPER TUBE

There are two methods of making a compression joint.

1. Insert the tube firmly into the compression fitting, ensuring that the compression ring seats centrally and that the tube makes firm contact with the tube stop in the body of the fitting.

2. Remove the compression nut and compression ring, then put the nut and then the ring on the tube. Insert the tube end up to the fitting's tube stop. Slide the ring and the nut down to the fitting body.
3. Tighten the nut using your fingers until tight.
4. Tighten the nut further using high quality open ended or adjustable spanners. Spanner flats are incorporated into the design of the fitting bodies. The second spanner must be used to prevent the fitting rotating as the nut is tightened. For normal joint making, tighten the nut 1 turn (360°) for fittings in sizes from 6mm to 12mm, or ¾ turn (270°) for fittings in sizes from 15mm to 54mm. A few drops of light oil on the threads will assist, especially on sizes 35mm and above. When jointing stainless steel or R220 copper tube some variation may be needed – the nut may be tightened further if necessary. Take care not to over tighten the compression nut, as this will not result in a stronger joint and could lead to problems in service.

### CONNECTING HALF HARD THICK WALLED R250 COPPER TUBE

This copper tube is significantly thicker than other varieties and special care needs to be taken during installation.

1. Ensure pipework is supported during and after installation, as thick-walled copper tube is less tolerant of stress on the joints. The pipework should be clipped as close as possible to the fittings, particularly where long runs are involved.
2. Use spanners of the correct size and length. More torque is required to tighten fittings with thick walled copper tube, and care should be taken to ensure neighbouring joints are not disturbed.

3. Apply a light oil to the threads and chamfers where possible. This will reduce assembly torque and minimise the risk of damage. This is essential on sizes above 28mm.
4. If a sealant is required, use a suitable PTFE based compound, e.g. Loctite 577 or PTFE tape.

### CONNECTING IMPERIAL COPPER TUBE

Pegler valves with compression connections can be used in maintenance applications to connect copper tube to former imperial sizes, such as BS 3931.

### CONNECTING CARBON STEEL AND STAINLESS STEEL TUBE

Stainless steel tube to BS EN 10312 (formerly BS 4127), DVGW GW541; and carbon steel tube to DIN 2394/ NEN 1982, can be jointed in sizes up to and including 28mm using Pegler compression fittings. Carbon steel tubes are for use on non potable closed circuit systems only. To achieve sound joints, the following precautions should be taken:

1. Ensure no flats or score marks are visible on the outside surface of the tube. The weld bead should not be visible.
2. A suitable jointing compound should be applied to the sealing faces prior to tightening of the compression nuts. Sealants with PTFE fillers are preferred, with PTFE tape as an alternative.



### FLANGE CONNECTIONS

Flange components have their own design limitations and correct selection and compatibility is vital.

Flange material specification:

- + Pressure and temperature must not exceed its rating.
- + Gasket selection must be in line with the rating of the flange.
- + The fluid being handled will affect the gasket selection.
- + All bolts must be compatible with the flange being used.

Pipe and its mating flanges should be cleaned and made ready for assembly.

A clean and appropriate gasket should be selected for the flange type being used. Flat face and raised faces should not be mixed.

Piping should be properly supported with use of correctly sized hanging or securing brackets.

All pipes need to be aligned correctly to ensure that the valve integrity is maintained, avoiding twisting and distortion of the valve's structure and valve damage.

As the valve is assembled ensure that the bolts are placed and secured with nuts at hand tightness employing the crossover method of tightening to secure a sound joint.

Butterfly valves provide positive shut off in both flow directions. The disc profile is designed to give sealing properties at minimum torque. Raised seat profile provides positive flange seal.



### WELD CONNECTIONS

Welded joints should be made by qualified installers having carried out the requisite risk assessments and health and safety considerations.



# Pegler Yorkshire

Follow us on



CONNECT  CONTROL

## UK ENQUIRIES

### UK SALES

Free Phone: 0800 156 0010

Free Fax: 0808 156 1011

Email: [uk.sales@pegleryorkshire.co.uk](mailto:uk.sales@pegleryorkshire.co.uk)

### TECHNICAL HELP

Free Phone: 0800 156 0050

Free Fax: 0808 156 1012

Email: [tech.help@pegleryorkshire.co.uk](mailto:tech.help@pegleryorkshire.co.uk)

### BROCHURE HOTLINE

Free Phone: 0800 156 0020

Free Fax: 0808 156 1011

Email: [info@pegleryorkshire.co.uk](mailto:info@pegleryorkshire.co.uk)

## INTERNATIONAL ENQUIRIES

### EXPORT

Tel: +44 (0) 1302 855 656

Fax: +44 (0) 1302 730 513

Email: [export@pegleryorkshire.co.uk](mailto:export@pegleryorkshire.co.uk)

**Tectite**

**XPress**

**Henco**

**Terrier**

**Meibes**

**Ballorex**

**Pegler**

**Prestex**

**Yorkshire**

**Endex**

**Kuterlite**

**Francis Pegler**

**Performa**



## HEAD OFFICE

### Pegler Yorkshire Group Limited

St. Catherine's Avenue, Doncaster,  
South Yorkshire DN4 8DF, England

Tel: +44 (0) 1302 560 560

Fax: +44 (0) 1302 560 203

Email: [info@pegleryorkshire.co.uk](mailto:info@pegleryorkshire.co.uk)

[www.pegleryorkshire.co.uk](http://www.pegleryorkshire.co.uk)

Registered in England Company No. 00401507

Registered Office: Haigh Park Road, Stourton,  
Leeds, West Yorkshire, LS10 1RT England

All brand names and logo styles are registered trademarks. Maintaining a policy of continual product development, Pegler Yorkshire reserves the right to change specifications, design and materials of products listed in this publication without prior notice

LIT.REF: ??????