

AQUASTEEL

FLOOR DRAINS

  
AQUASTEEL





FLOOR DRAINS



**water captured by the charm of steel**  
drainage systems that meet any architectural demand



  
AQUASTEEL





Always sensible to environmental issues, in the summer of 2013 FERPLAST chose to power the factory by installing photovoltaic panels on its rooftop, thus cutting the annual energy consumption by 70% and sensibly reducing CO<sub>2</sub> pollution.

*TOP VALVE*®



*SLIMKIT*



# TOP VALVE®



Floor drains are essential either to clean large areas or to drain water in case of foods.

Two are the traditional methods to prevent smelly sewer gases from coming back into the rooms of a building: either a water seal or a trap which seals for gravity. Both these solutions are unsatisfactory because of the problems they may create.

Our innovative solution The TOP VALVE® acts as a non return valve The TOP VALVE® is an innovative, FERPLAST patent product. It is made of a thermoplastic recyclable polymer body and a silicone membrane designed to open for gravity when water flows and to hermetically reseal when the discharge has ceased.

Apart from preventing smelly sewer gases and insects from entering the rooms, FERPLAST innovative valve also prevents floods caused by blackflow of foul water, thanks to its watertight seal.

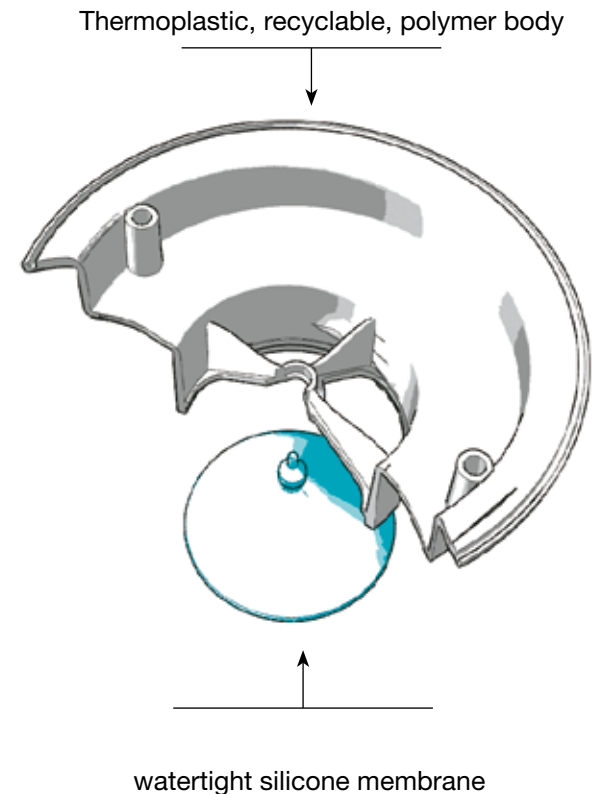

## Advantages

---

- Fast and easy to install and replace
- Functional and easy to maintain and clean
- High temperature and corrosion resistant
- Smelly sewer gases and insect stop
- No Floods caused by backflow of foul water



# SLIM KIT

FERPLAST has designed a new drainage system which facilitates installation and it is the perfect solution when installation heights are limited.

Our SLIMKIT is the perfect complement to the TOP VALVE, but it can be combined with other FERPLAST articles.

It consists of two parts made of ABS plastic: the base BA40 and the adaptor with a temporary lid AD15. The SLIMKIT gives the opportunity to install the stainless steel floor drain only at the end of works and, in future, to change an installed floor drain without damaging the floor finish.

The AD15 temporary lid, used during works, prevents site debris from entering the drainage. Once works are over it is to be removed to install the stainless steel drain.

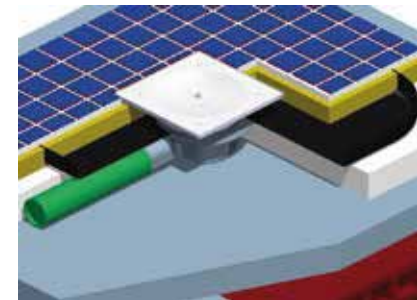
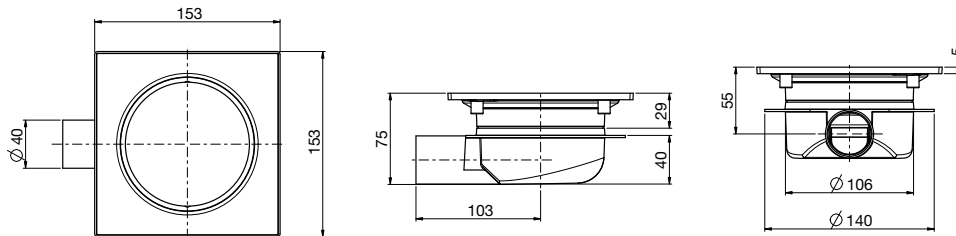



BA40

Bordo superiore asportabile mediante l'uso di una pinza  
The rim can be removed by means of pliers

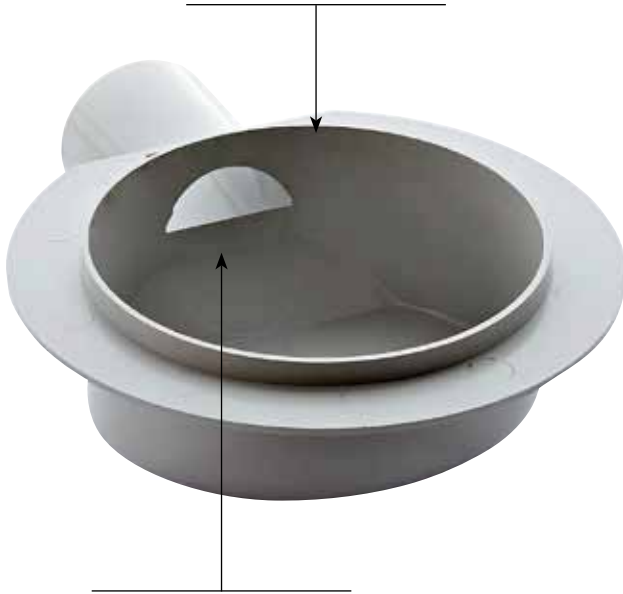

Paratia di sifonaggio da rimuovere solo con l'uso del TOP VALVE  
Flap to be cut off when using TOP VALVE

AD15

Tappo provvisorio di protezione  
Temporary plastic lid

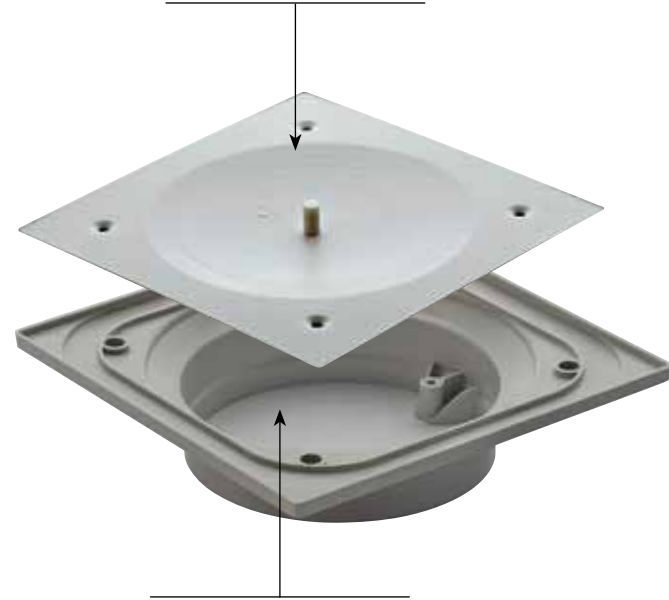

Adattatore nel quale va inserita la piletta  
*Adaptor on which the floor drain will be installed*

---

### Advantages

- Very low installation height
- No site debris into the drainage during works
- Possibility to change an installed floor drain without damaging the floor finish

Reverse System  
The LINEARDRAIN cover plate, supplied with two plastic supports (foto 1), can be reversed to accommodate ceramic, marble, glass or wood tiles (foto 2).

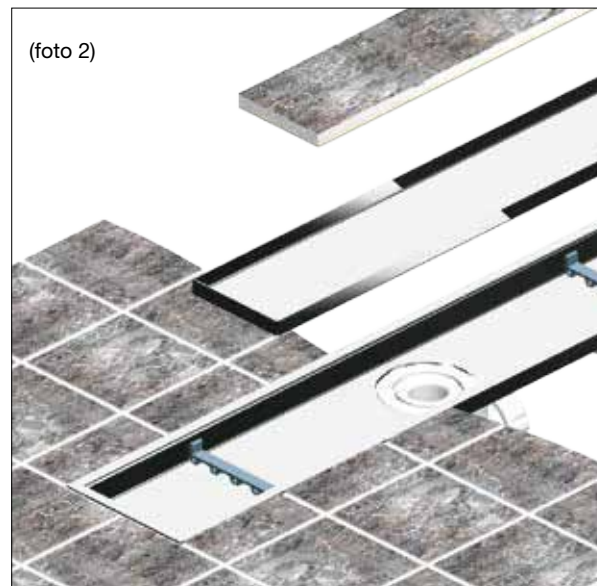
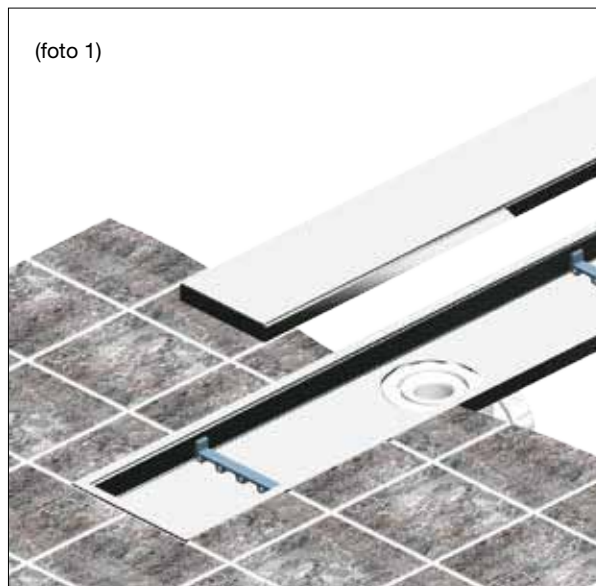

S10090/STC



S10090/STC  
LINEARDRAIN with plastic siphon.

S10090/STC TV  
Con TOP VALVE®.  
With TOP VALVE®

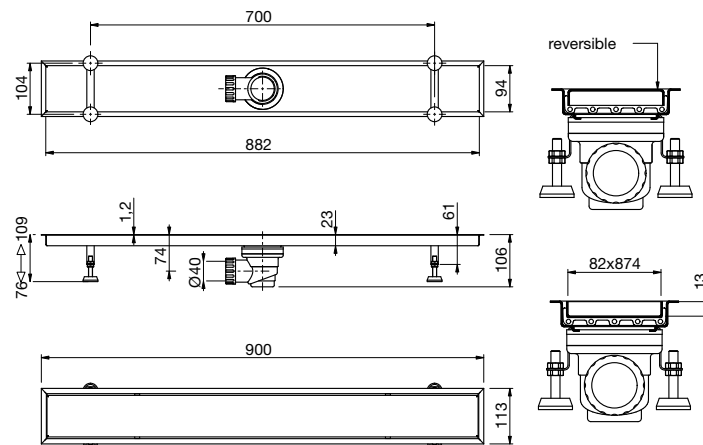

Height adjustable feet for easy installation and levelling

Accessori  
Options

BA40



900x100

S10090/S1  
LINEARDRAIN with plastic siphon.

S10090/S1 TV  
Con TOP VALVE®.  
With TOP VALVE®

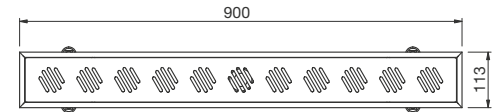
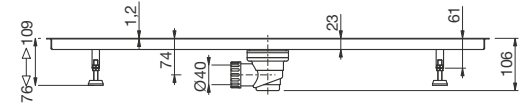
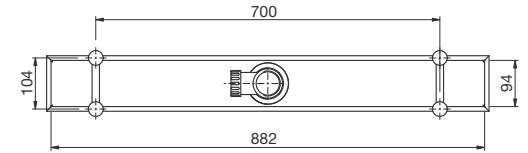

BA40

Accessori  
Options



S10090/S1



S10090/S2

S10090/S2TV  
Con TOP VALVE®  
With TOP VALVE®

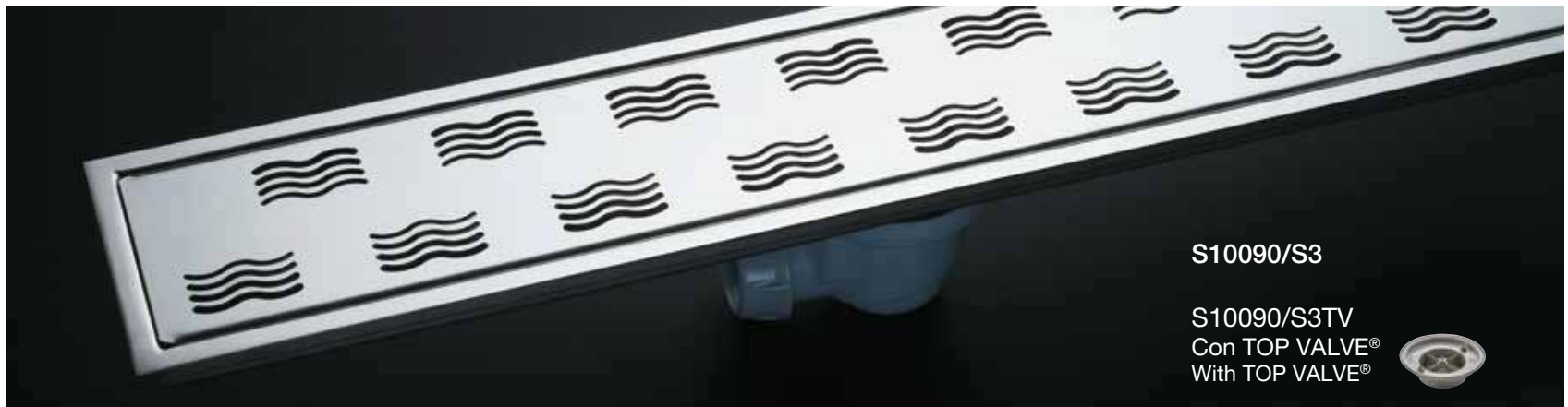

S10090/S3

S10090/S3TV  
Con TOP VALVE®  
With TOP VALVE®



S10090/S4

S10090/S4TV  
Con TOP VALVE®  
With TOP VALVE®



### Reverse System

The LINEARDRAIN cover plate, supplied with two plastic supports (foto 1), can be reversed to accommodate ceramic, marble, glass or wood tiles (foto 2).

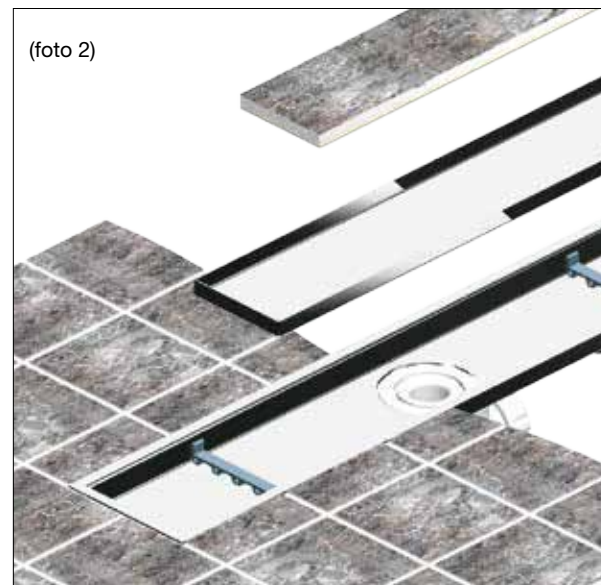
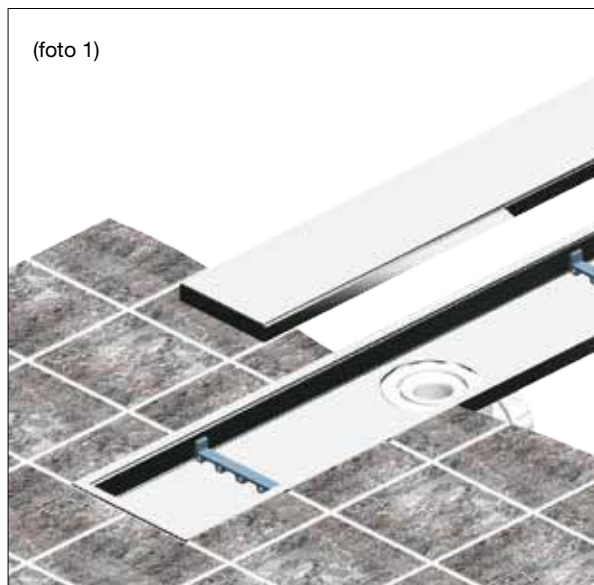

S10060/STC



S10060/STC



S10060/STC  
LLINEARDRAIN with plastic siphon.

S10060/STC TV  
Con TOP VALVE®.  
With TOP VALVE®



Height adjustable feet for easy installation and levelling

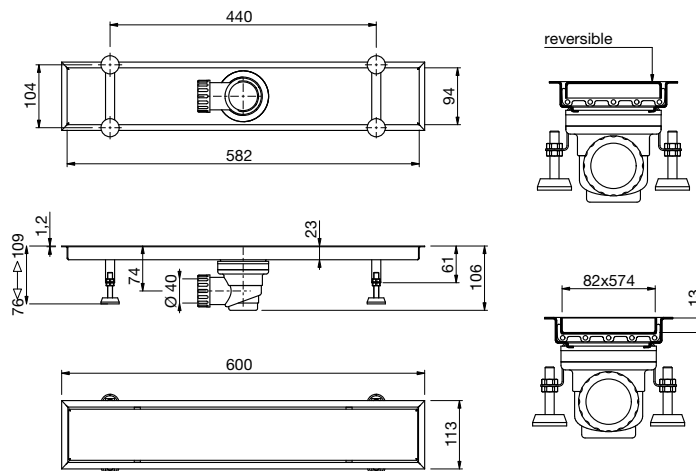

BA40

Accessori  
Options



600x100

S10060/S1  
LINEARDRAIN with plastic siphon.

S10060/S1 TV  
Con TOP VALVE®.  
With TOP VALVE®

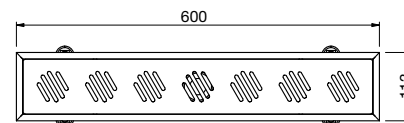
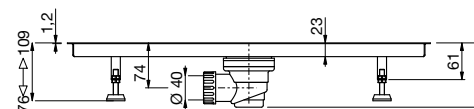
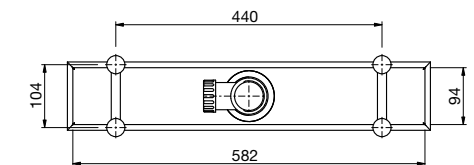

BA40

Accessori  
Options





S10060/S2

S10060/S2TV  
Con TOP VALVE®  
With TOP VALVE®



S10060/S3

S10060/S3TV  
Con TOP VALVE®  
With TOP VALVE®

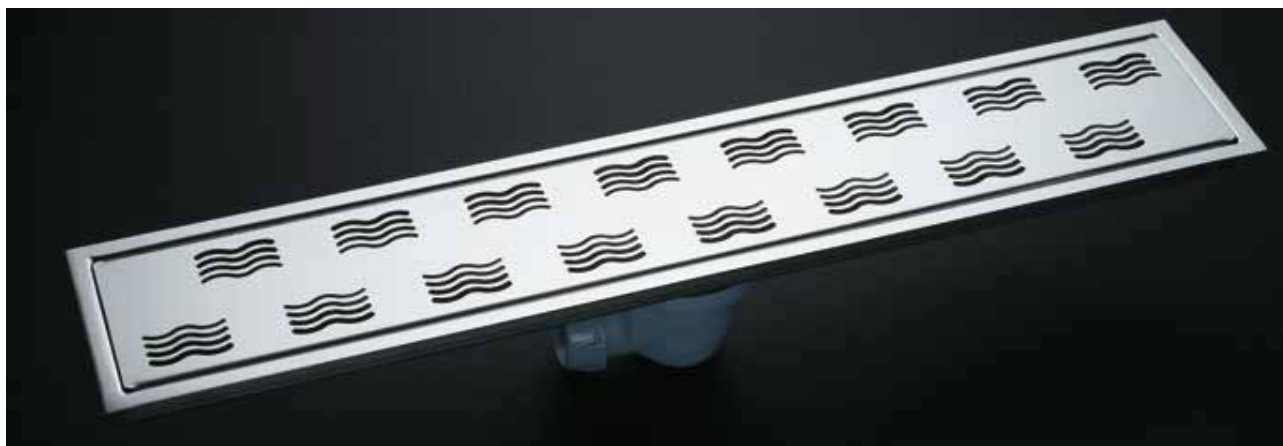

S10060/S4

S10060/S4TV  
Con TOP VALVE®  
With TOP VALVE®

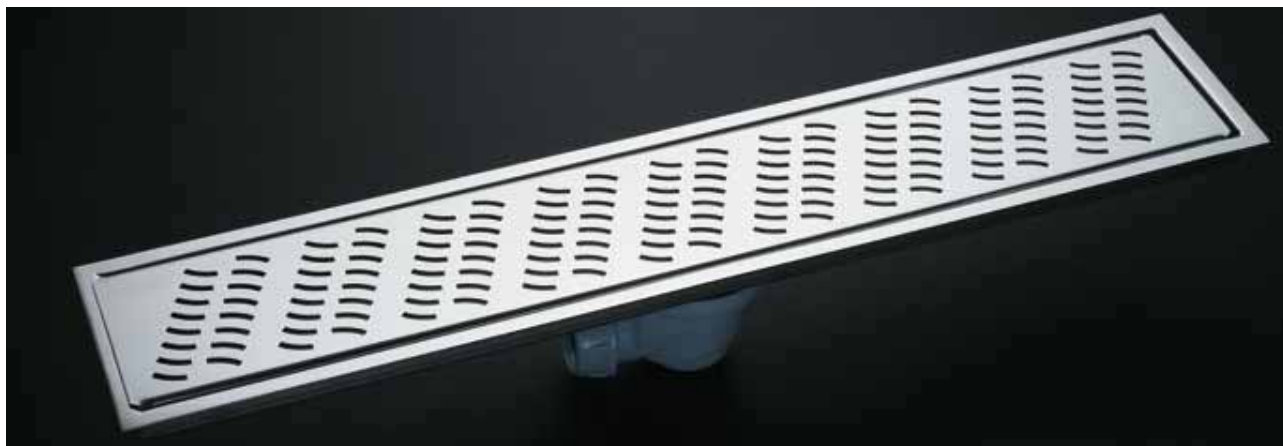

Direct outlet

Siphoned



S10030  
LINEARDRAIN con griglia.

S10030 TV  
Con TOP VALVE®.  
With TOP VALVE®



S10030/S  
LINEARDRAIN with grate and plastic siphon

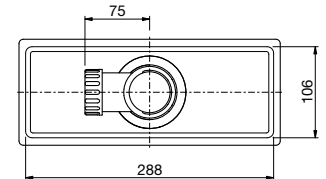
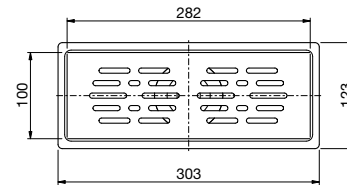
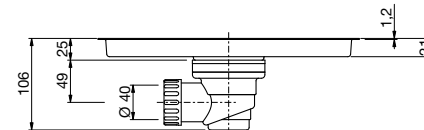
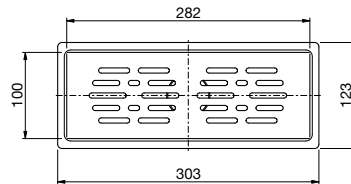
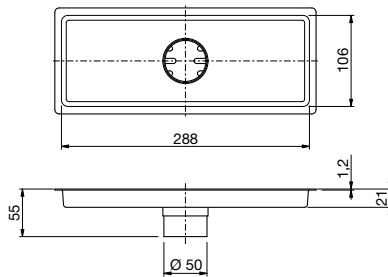

BA40



Accessori  
Options



S10030

Direct outlet

Siphoned



P10030  
LINEARDRAIN with tile holder

P10030 TV  
Con TOP VALVE®.  
With TOP VALVE®



P10030/S  
LINEARDRAIN with tile holder and plastic siphon

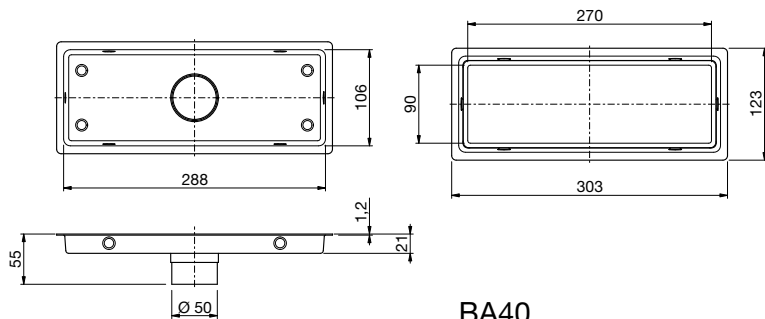

Accessori  
Options

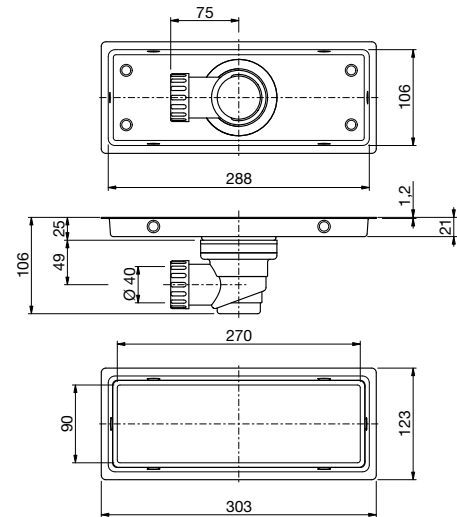



P10030

Direct outlet

Siphoned



AP10030/1  
LINEARDRAIN with tile holder  
and handmade tempered glass  
insert

AP10030 TV/1  
Con TOP VALVE®.  
With TOP VALVE®



AP10030/1S  
LINEARDRAIN with tile holder, handmade tempered  
glass insert and plastic siphon

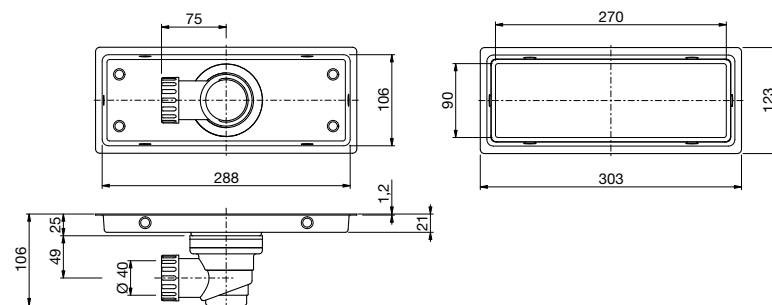
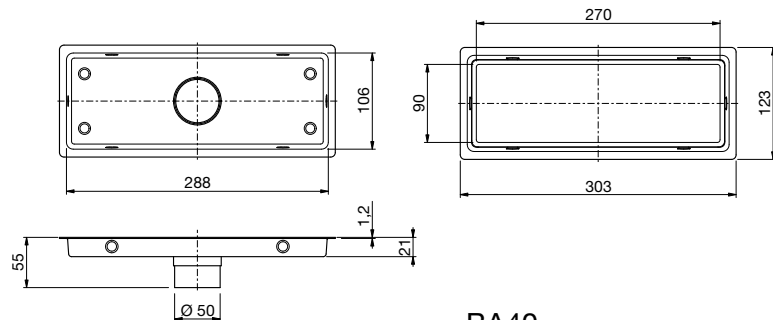

BA40



Accessori  
Options

# Vetri d'Autore - Design Handmade glasses

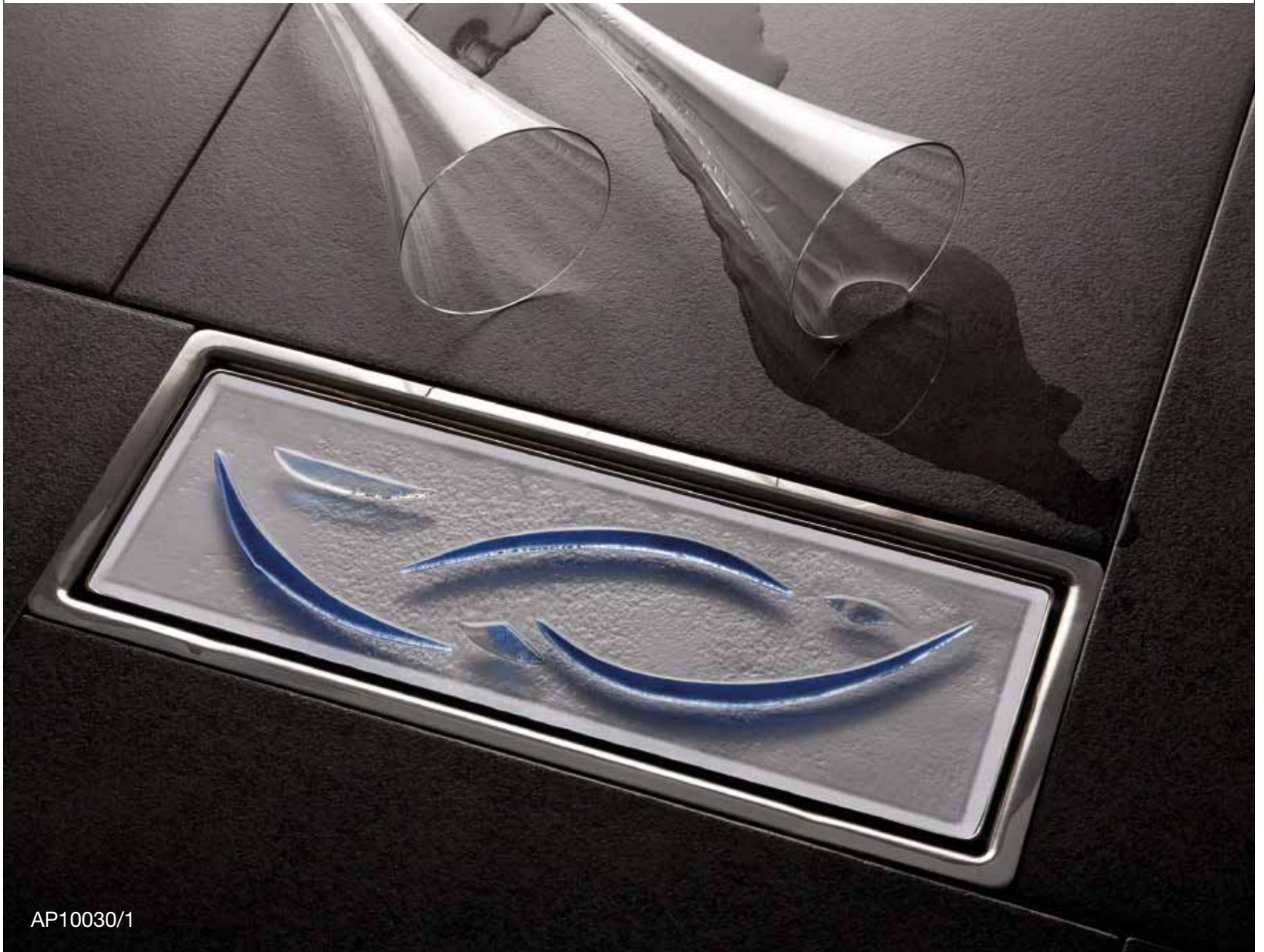

AP10030/1

As shown in the pictures, different glass insert designs are available for the 300x100mm LINEARDRAIN.  
Being handmade, changes in colour or design are possible.

AP10030/2 - Direct outlet  
AP10030/2S - Siphoned  
AP10030 TV/2  
Con TOP VALVE®.  
With TOP VALVE®



Handmade white or black frosted glass insert



## Frosted glasses design handmade by skillful Italian craftsmen

As shown in the pictures, different glass insert designs are available for the 300x100mm LINEARDRAIN.  
Being handmade, changes in colour or design are possible.

AP10030/2 - Direct outlet  
AP10030/2S - Siphoned  
AP10030 TV/2  
Con TOP VALVE®.  
With TOP VALVE®



Handmade white or black frosted glass insert



131x131

PP112



PP112

Cleanout with tile holder and gasket.

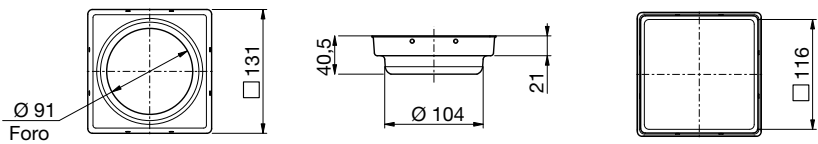

Direct outlet



Direct outlet Ø 50



**PP111**  
Floor drain with tile holder.

**PP111 TV**  
Con TOP VALVE®.  
With TOP VALVE® 

**PP111/50**  
Floor drain with tile holder.

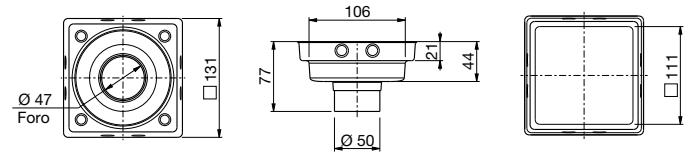
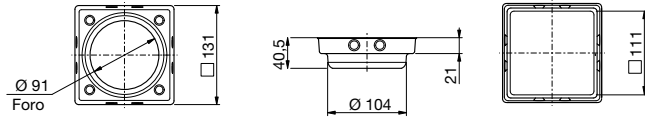

Accessori  
Options



131x131

PS111



Siphoned

Floor drain with tile holder and plastic siphon

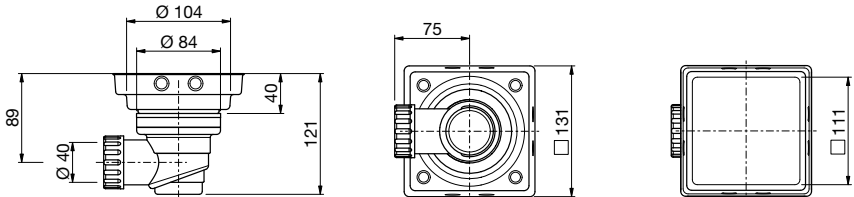

Direct outlet Ø 60 PPP60



PPP60

Direct outlet Ø 50



PPP50

PPP60  
Floor drain with tile holder.

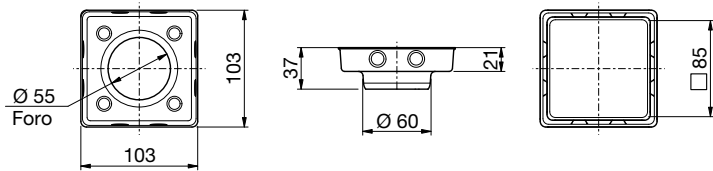

PPP50  
Floor drain with tile holder.

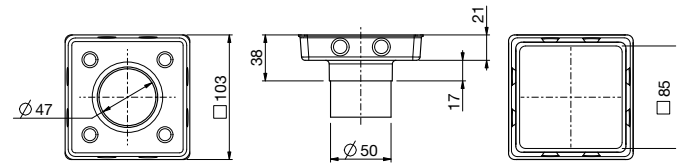

103x103

Siphoned

Direct outlet Ø 38



PPS40  
Floor drain with tile holder and plastic siphon

PPP38  
Floor drain with tile holder.

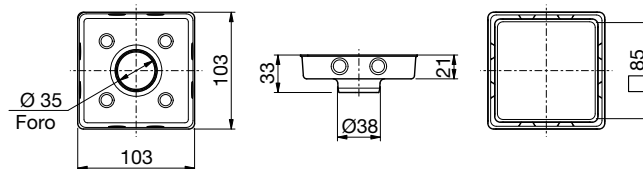
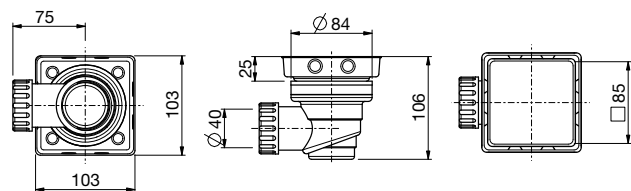



As shown in the pictures, different tempered glass insert designs are available for the 131x131mm and 103x103mm floor drains. Being handmade, changes in colour or design are possible.





Tempered glasses handmade by skillful Italian craftsmen

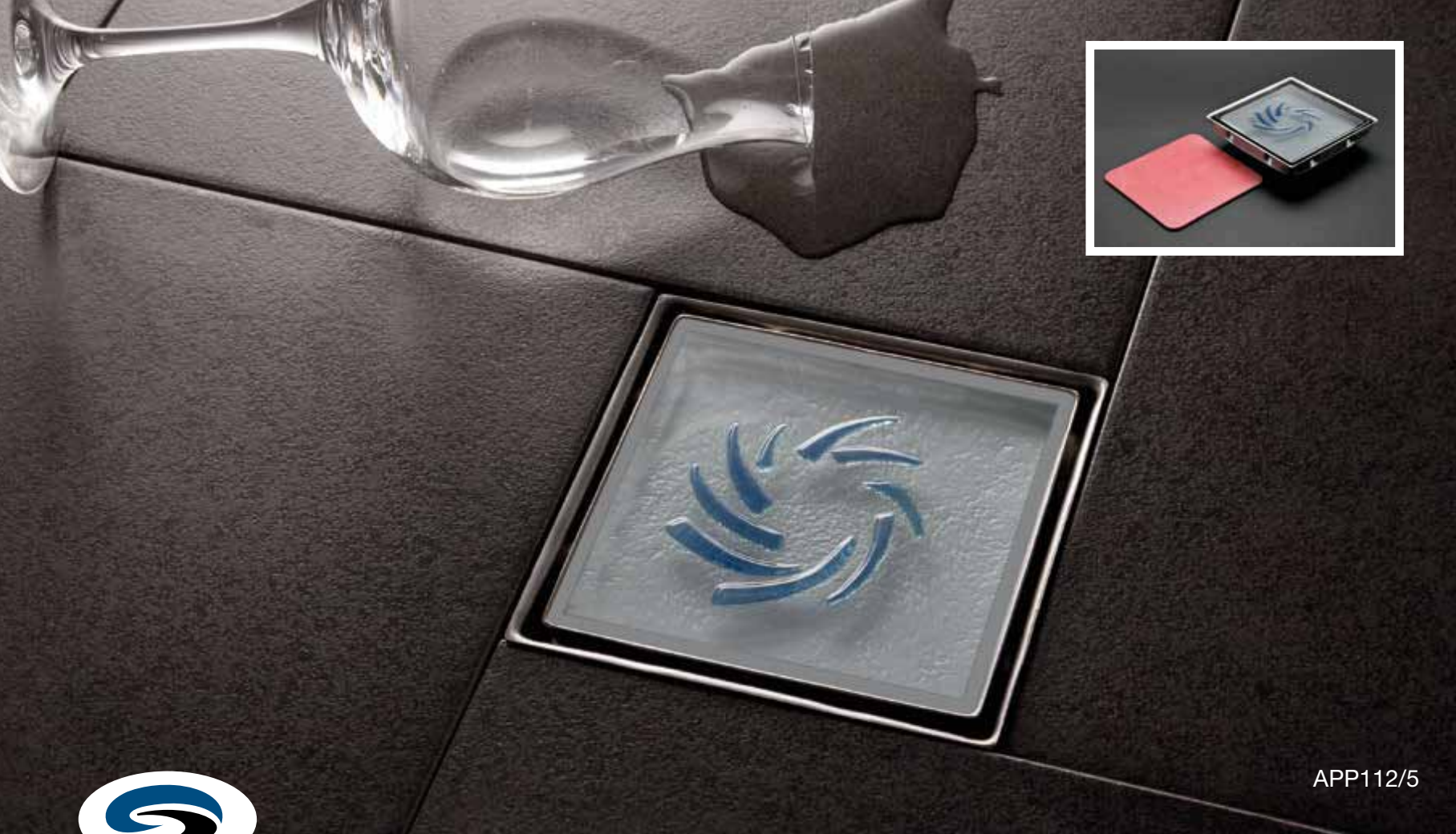

APP112/5



APP112/5

Cleanout with tempered glass insert and gasket.

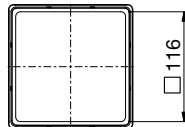
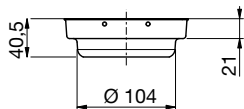
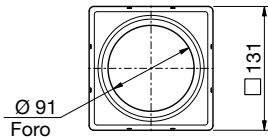

APP112/4



APP112/6

900x100

103x103



APP111/5

APP111 TV/5



APP111/6

APP111TV/6



APP111/4

APP111TV/4



## APP111

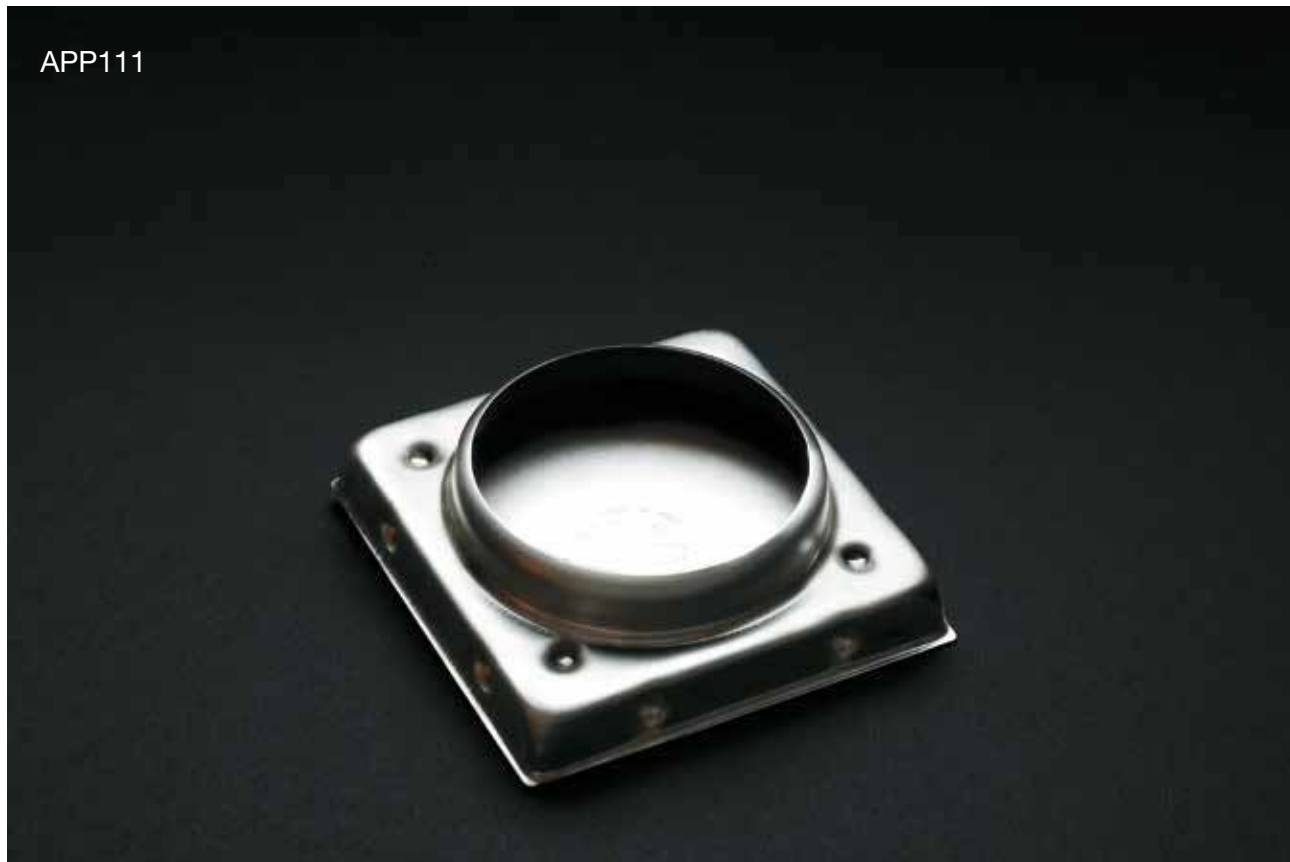

Direct outlet  
Floor drain with tempered glass insert.

APP111 TV  
Con TOP VALVE®.  
With TOP VALVE®

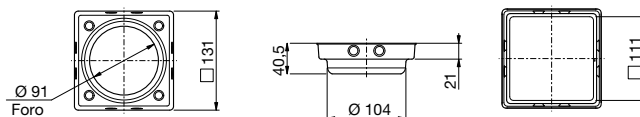

Accessori  
Options

BA40



APP111/50



APP111/50-5



APP111/50-6



APP111/50-4



Direct outlet Ø 50

Floor drain with tempered glass insert.

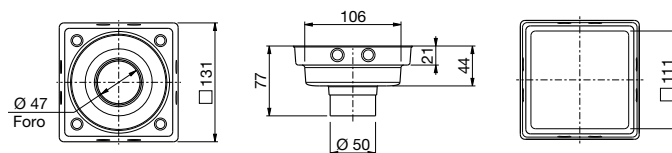

131x131

APS111/4



APS111/5



APS111/6



Siphoned  
Floor drain with glass insert and plastic siphon.

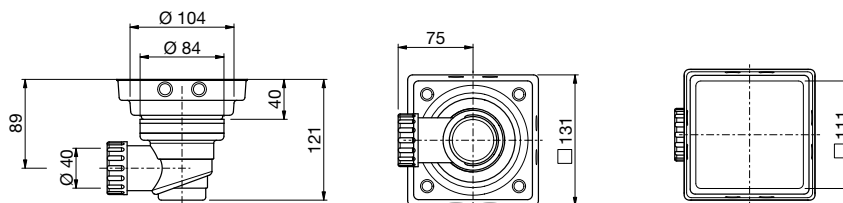



APPP38/5



APPP38/4



APPP38

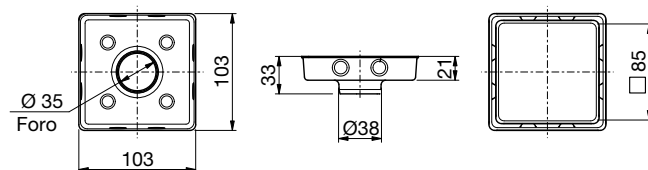

**APPP38/6**  
Floor drain with tempered glass insert.

APPP60/6



APPP60/6

Floor drain with tempered glass insert.

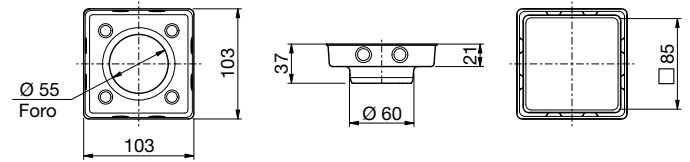

APPP60/5



APPP60/4

APPP50/6



APPP50

Floor drain with tempered glass insert.

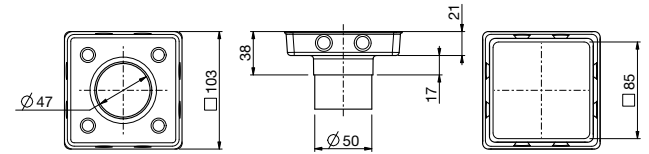

APPP50/5



APPP50/4

APPS40/4

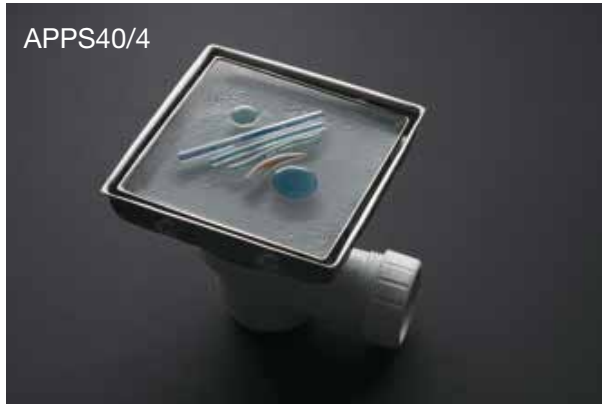

APPS40/4

Floor drain with tempered glass insert and plastic siphon

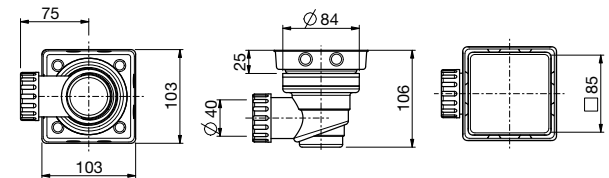

APPS40/5



APPS40/6

403/50

siphoned



Floor drain with stainless steel siphon

403/40

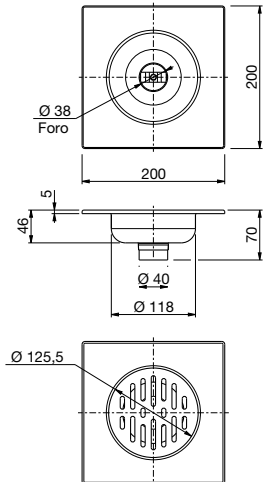

403/50

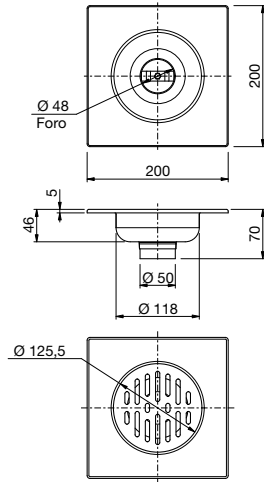

403/40





103x103

siphoned



Floor drain with stainless steel siphon

401/40

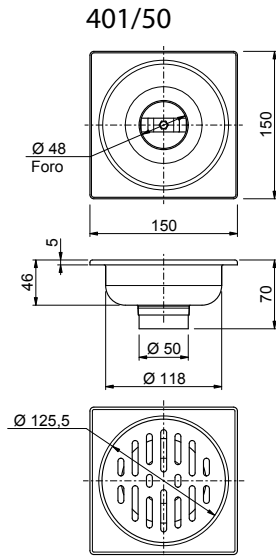
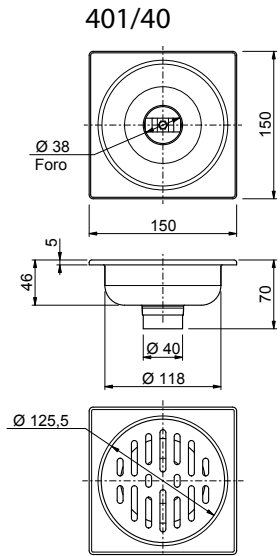

401/50

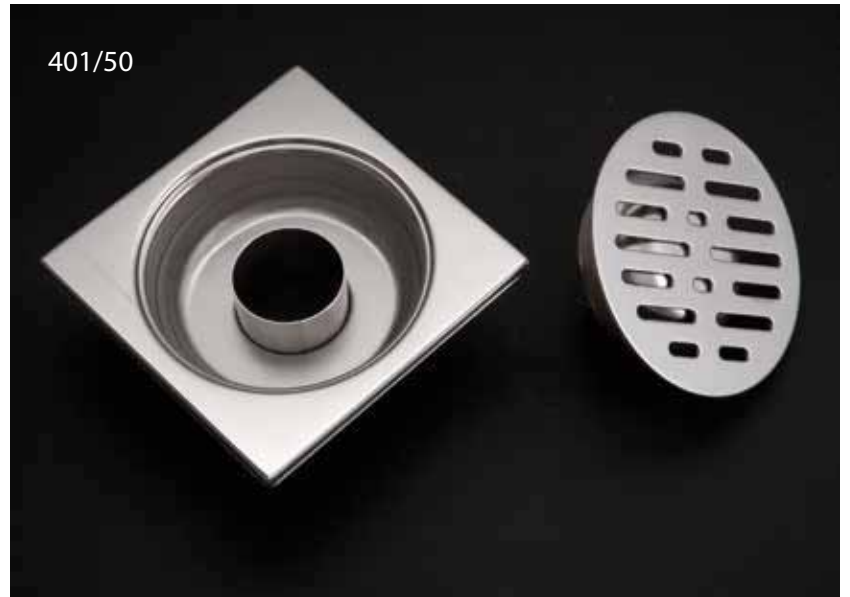

siphoned



Floor drain with stainless steel siphon



402/40

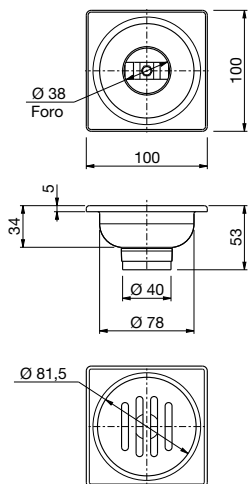

402/50

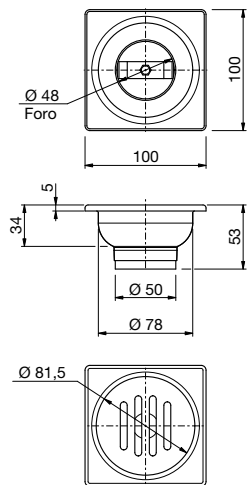

402/50



200x200



205

205  
Floor drain with screwed grate and cover  
plate with central screw.

205 TV  
Con TOP VALVE®.  
With TOP VALVE®

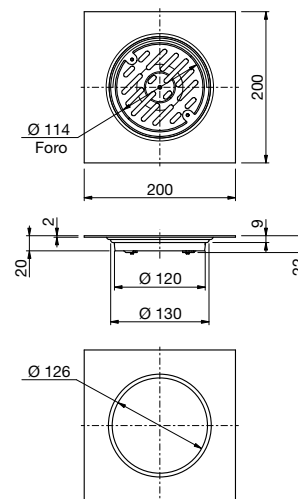
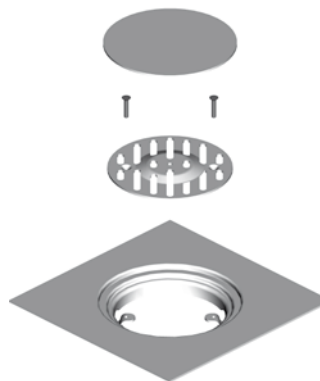

204  
Floor drain with  
screwed grate.

204 TV  
Con TOP VALVE®.  
With TOP VALVE®

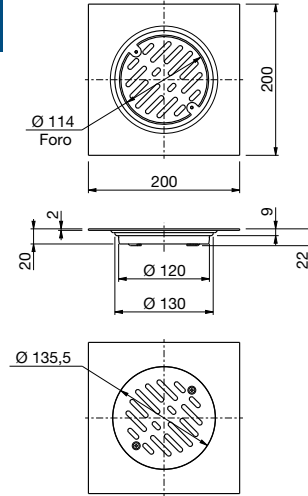

203

Floor drain with  
screwed grate and  
cover plate.

203 TV  
Con TOP VALVE®.  
With TOP VALVE®

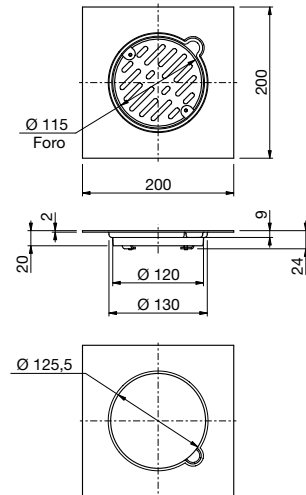

200x200

202  
Floor drain with grate  
and cover plate.

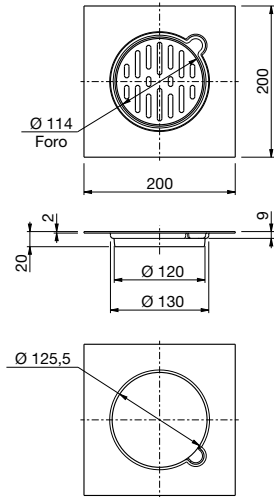

202

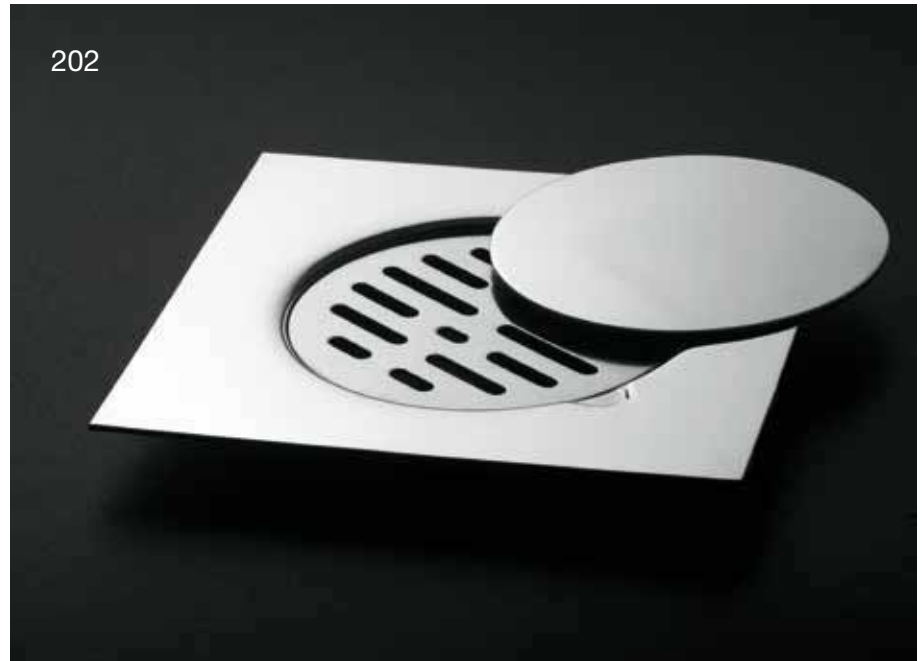

201  
Cleanout with screwed cover plate and 3mm thick gasket.

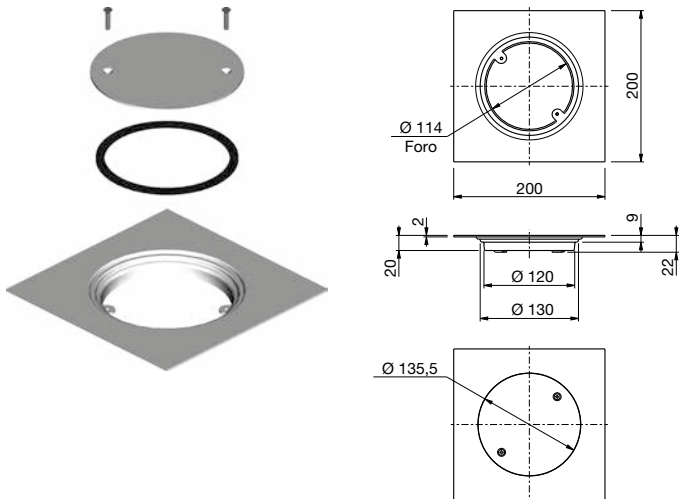

201





203A/103

Rounded edge floor drain with  
screwed grate and cover plate.

203A/103TV  
Con TOP VALVE®.  
With TOP VALVE®



Accessori - Options

BA40

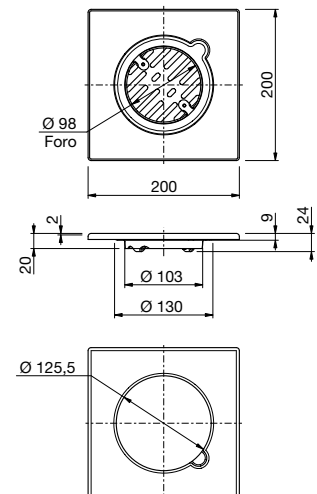

200x200



205/103

205/103  
Floor drain with screwed grate and cover  
plate with central screw.

Accessori - Options

205/103TV  
Con TOP VALVE®.  
With TOP VALVE®



BA40

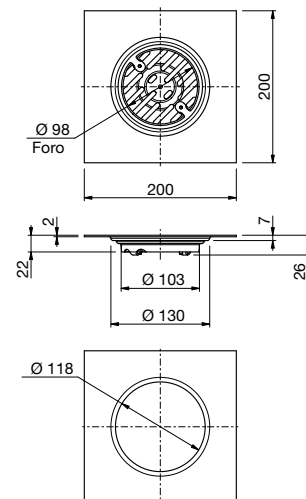
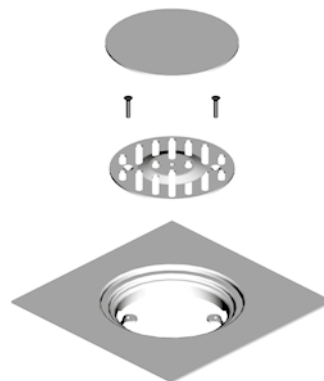

**201/103**  
Cleanout with screwed cover plate  
and 3mm thick gasket.

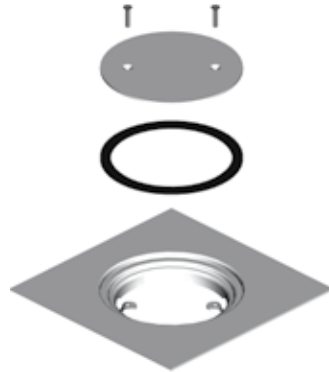
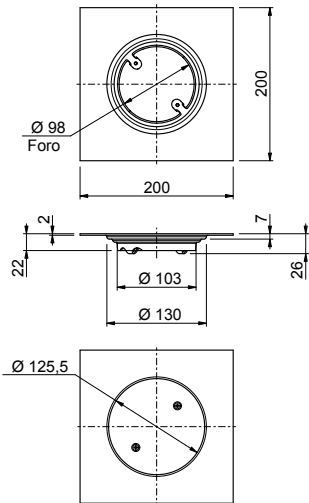

201/103

**209C**  
Floor Drain with pressure cover  
plate.

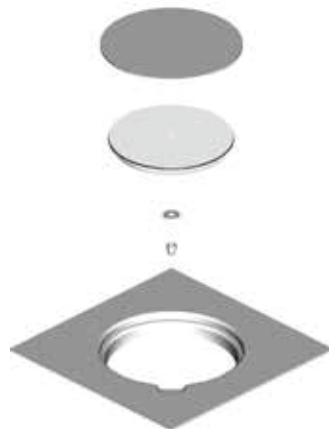
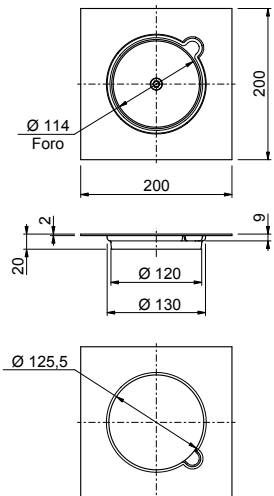

209C



200x200

20170

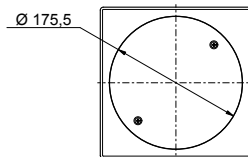
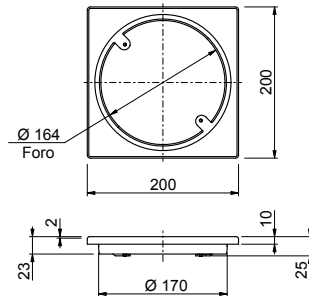
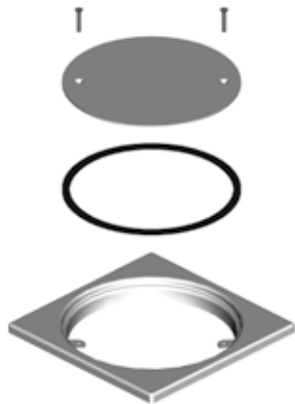

20170

Rounded edge cleanout with screwed cover plate and 3mm thick gasket.

**156**  
Floor drain with screwed grate and cover plate with central screw.

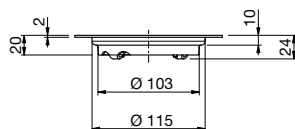
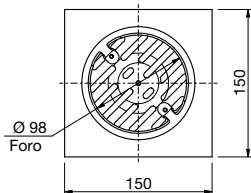
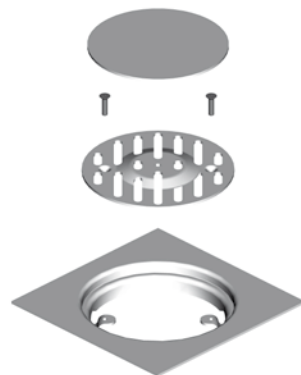

**156 TV**  
Con TOP VALVE®.  
With TOP VALVE®

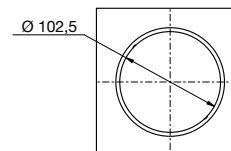
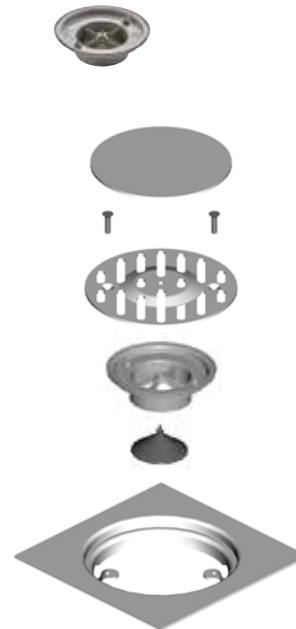

Accessori - Options

**BA40**



**AD15**



**BA40+AD15**





**151**  
Cleanout with screwed cover plate and 3mm thick gasket.

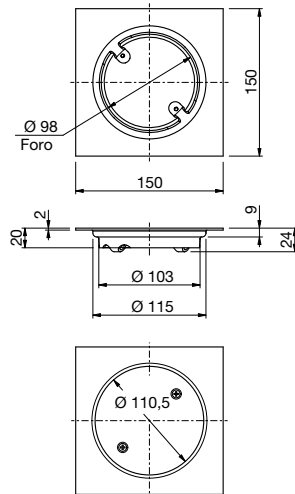

Accessori - Options

AD15



**152**

Floor drain with screwed grate.

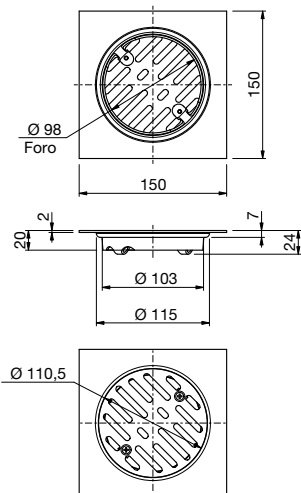

**152 TV**  
Con TOP VALVE®.  
With TOP VALVE®



Accessori - Options

BA40

AD15

BA40+AD15



153

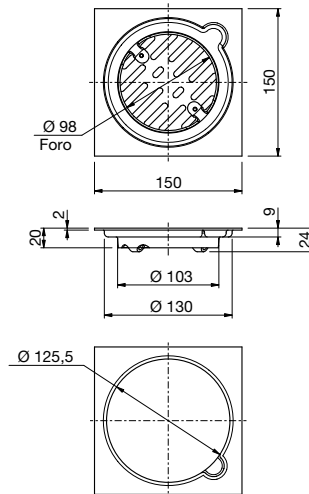

150x150

153  
Floor drain with screwed  
grate and cover plate.

Accessori - Options  
BA40



154

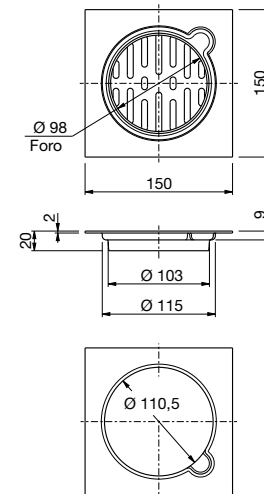

154  
Floor drain with grate and  
cover plate.

Accessori - Options  
BA40



154A  
Rounded edge floor drain,  
with grate and cover plate.

Accessori - Options

BA40

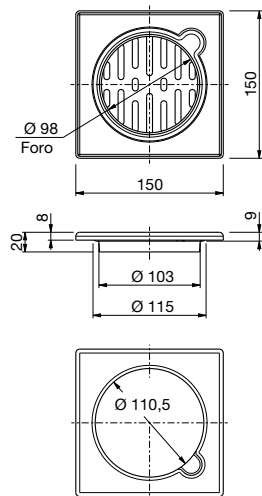

154A

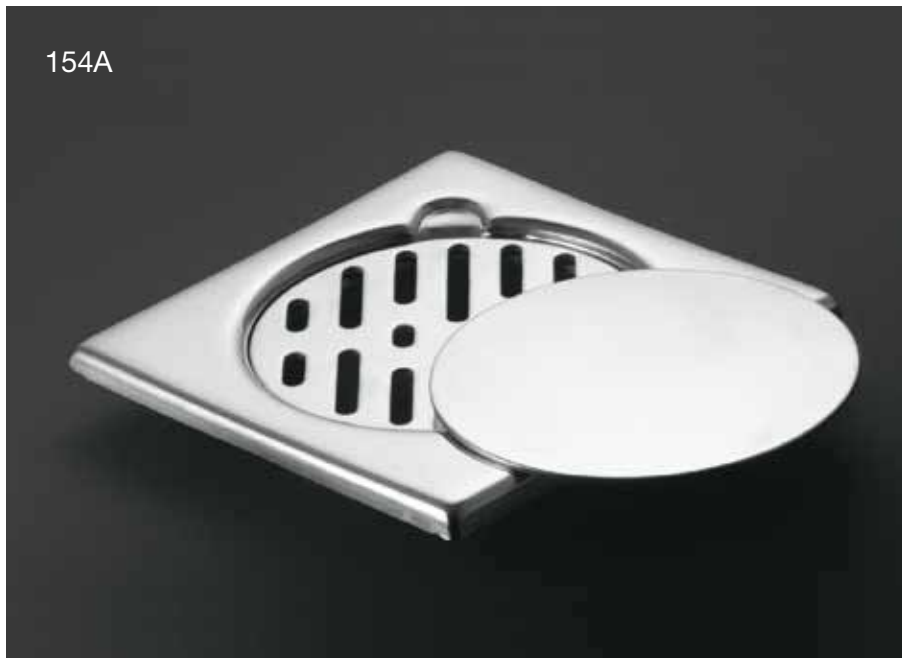

155A  
Rounded edge floor drain  
with screwed grate and  
cover plate.

155ATV  
Con TOP VALVE®.  
With TOP VALVE®



Accessori - Options

BA40

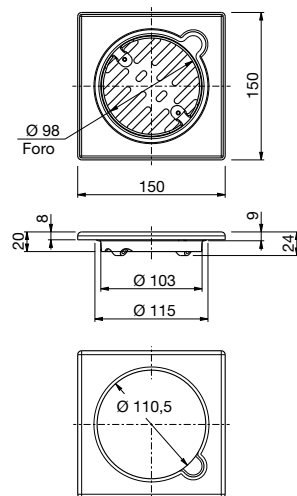

155A



150x150

155

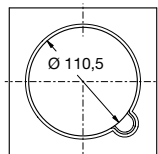
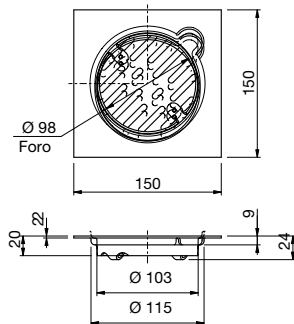

155

Floor drain with screwed grate and cover plate.

155TV  
Con TOP VALVE®.  
With TOP VALVE®



Accessori - Options



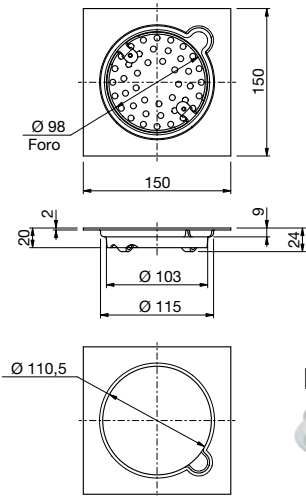

**155F**  
Floor drain with holed screwed grate and cover plate.

**155FTV**  
Con TOP VALVE®.  
With TOP VALVE®



Accessori - Options

BA40

AD15

BA40+AD15

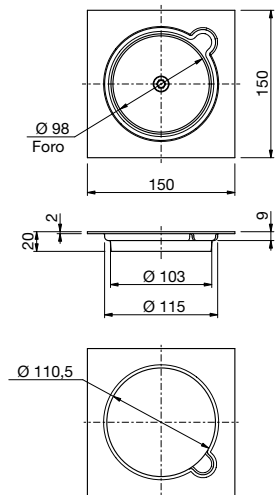

**159C**  
Floor Drain with pressure cover plate.

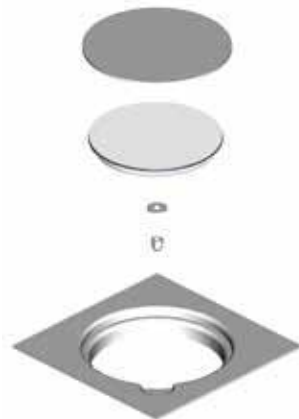



157



150x150



157  
Floor drain with “click clack” cover plate  
which pops up.

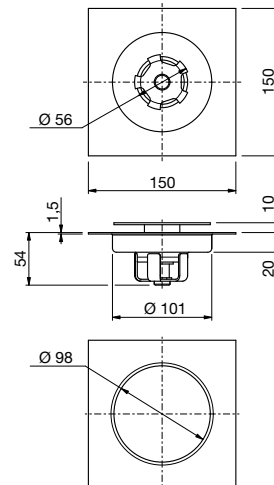

Accessori - Options

AD15

BA40+AD15





158

**158**  
Polymer plastic floor drain with stainless steel  
screwed grate and hinged cover plate.

**158 TV**  
Con TOP VALVE®.  
With TOP VALVE®



Accessori - Options

**BA40**

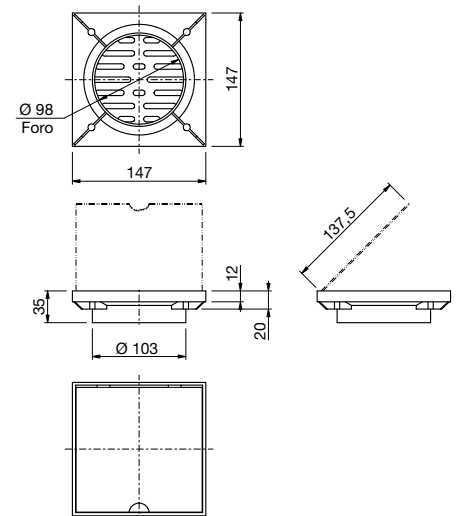
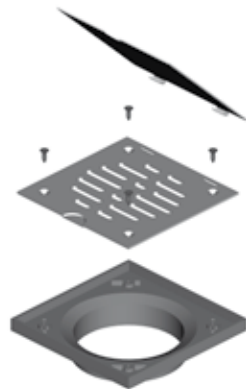



103  
Floor drain  
with screwed  
grate and cover  
plate.



103  
Attacco -Connection  
Ø 60mm

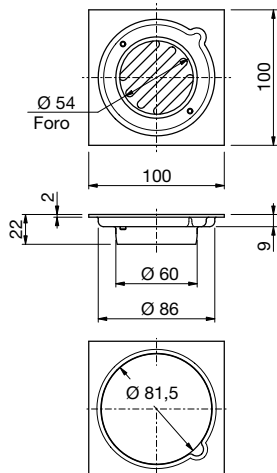

103/49  
Attacco -Connection  
Ø 49mm

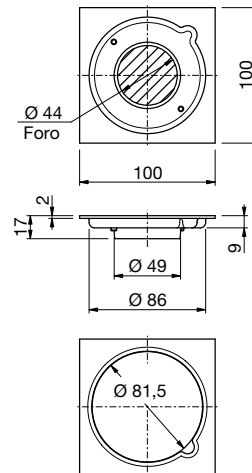

103/51  
Attacco -Connection  
Ø 51mm

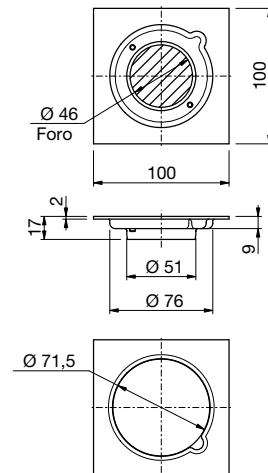

100x100

103S

103S  
Floor drain with grate and  
cover plate.



103S  
Attacco -Connection  
Ø 60mm

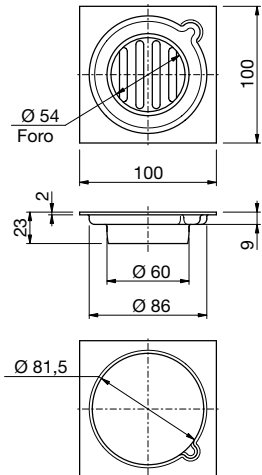

103S/49  
Attacco -Connection  
Ø 49mm

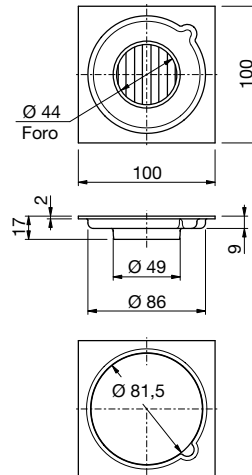

103S/51  
Attacco -Connection  
Ø 51mm

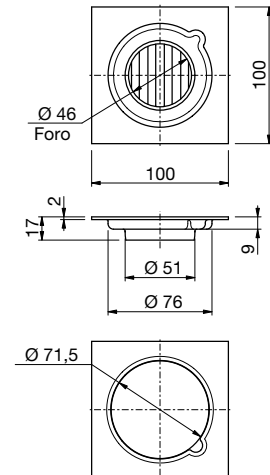

103F  
Floor drain with  
holed screwed  
grate and cover  
plate.



103F  
Attacco -Connection  
Ø 60mm

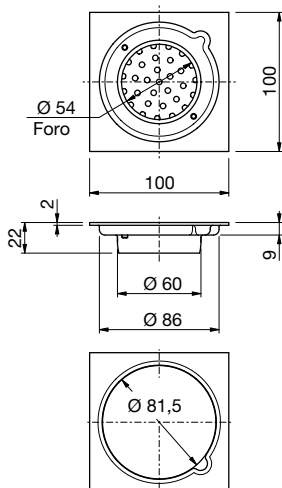

103F/49  
Attacco -Connection  
Ø 49mm

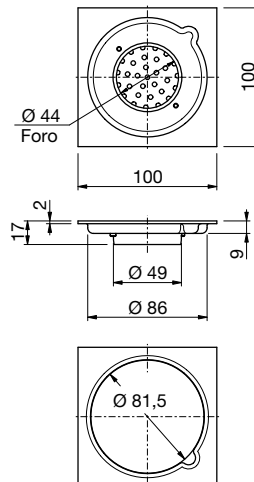

103F/51  
Attacco -Connection  
Ø 51mm

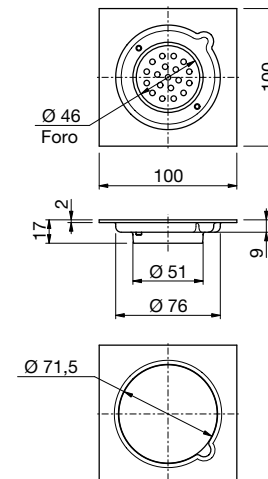

100x100

103SF  
Floor drain with holed grate  
and cover plate.



103SF  
Attacco -Connection  
Ø 60mm

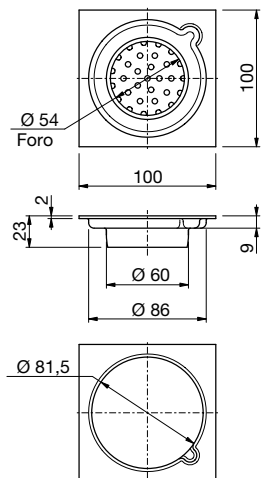

103SF/49  
Attacco -Connection  
Ø 49mm

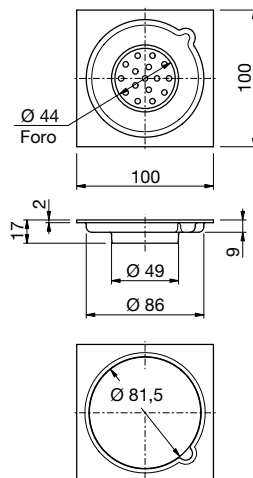

103SF/51  
Attacco -Connection  
Ø 51mm

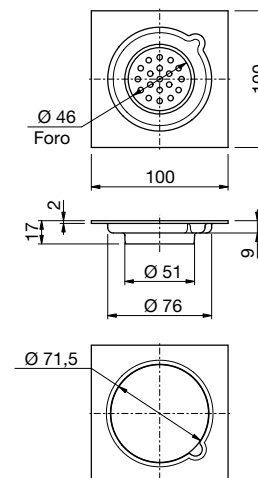

101  
Floor drain with  
screwed grate.

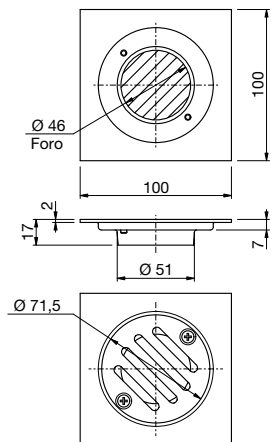

106F  
Floor drain with screwed grate and cover plate  
with central screw.

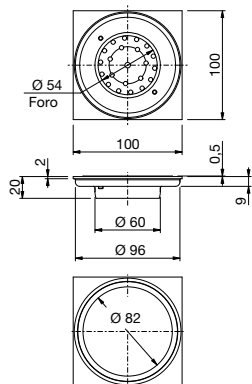
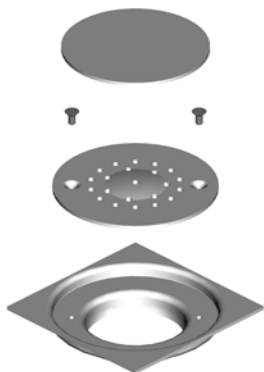



101CO



100x100

101CO

Cleanout with screwed cover plate and 3mm thick gasket.

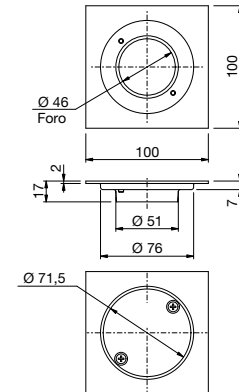
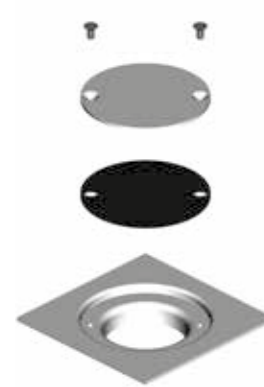

102CO



102CO

Cleanout with screwed cover plate and 3mm thick gasket.

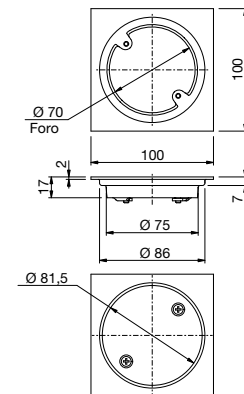
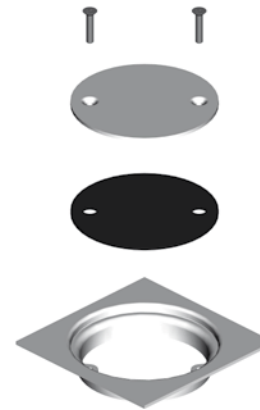

Floor drain  
with screwed  
grate.



102  
Attacco -Connection  
Ø 75mm

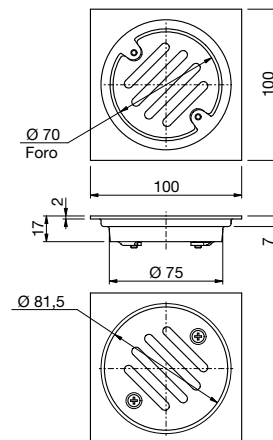

102/60  
Attacco -Connection  
Ø 60mm

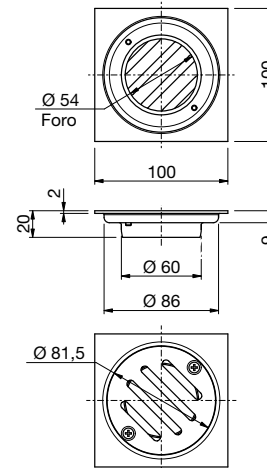

100x100

107

107  
Floor drain with  
“click clack”  
cover plate  
which pops up.

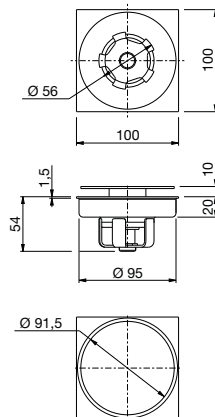



**802**  
Floor drain with screwed grate.

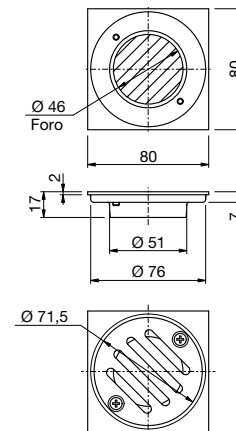

**802CO**



**802CO**  
Cleanout with screwed cover plate and 3mm thick gasket.

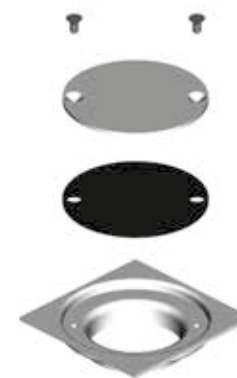
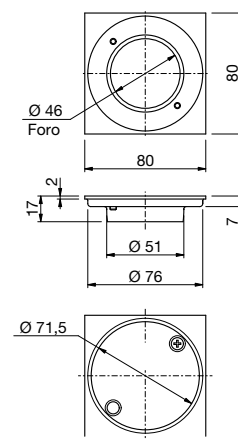

80x80

801  
Floor drain with holed,  
screwed grate.

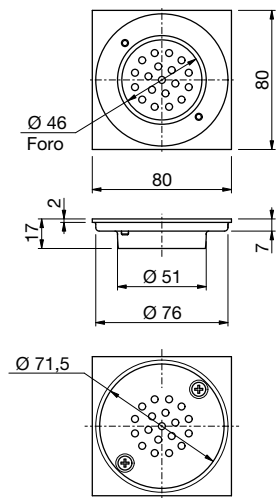

801



803  
Floor drain with screwed  
grate and cover plate.

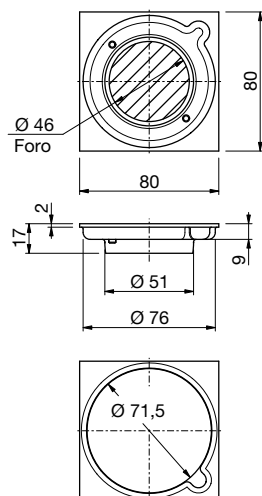

803



## Metal Finishes



... - O  
Old Effect



... - M  
Scotchbrite



... - C  
Copper Plated



... - G  
18 kt Gold



All Ferplast floor drains are available in 4 metal finishes

## Marble Finishes



... - MC  
White of Carrara



... - MRC  
Pink of Candoglia



... - MB  
Botticino

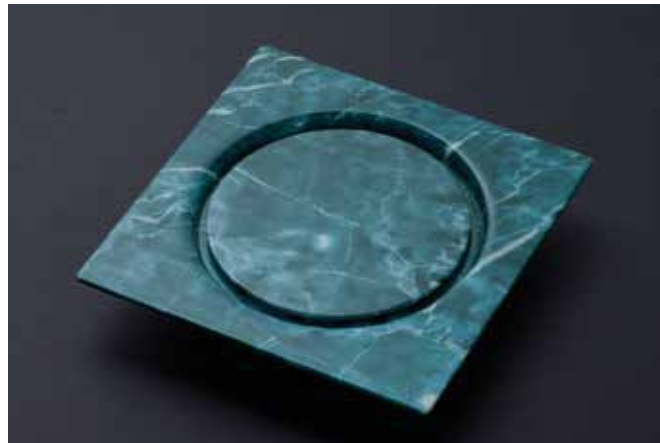

... - MVP  
Green of Prato





All Ferplast floor drains are available in 4 marble finishes

## Customizable Grates

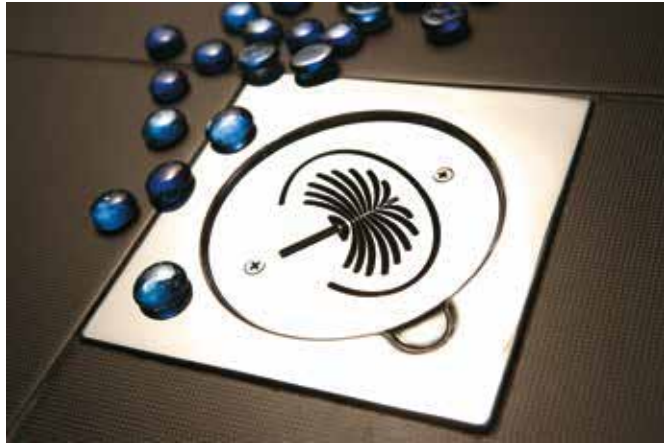





FLOOR DRAINS



AQUASTEEL