



REHAU[®]

Unlimited Polymer Solutions



RAUTITAN PEX PLUMBING SYSTEM

Secure. Easier. Faster.





100%
leak-proof
joint

SECURE

Simple. Robust. Reliable.



RAUTITAN PIPES

RAUTITAN pipes are made from high density cross-linked polyethylene (PE-Xa). The cross linking process causes the individual polyethylene molecules to bond in a three-dimensional network creating a tough and durable pipe with superior:

- long-term stability
- high temperature resistance and
- high pressure resistance
- superior flexibility and strength.

The external black PE-sheath blocks more than 99.9% of light transmission through the pipes to prevent the growth of algae within the plumbing system to maintain the system's hygiene.

FLEXIBLE CROSS-LINKED POLYETHYLENE (PEX) SYSTEM WITH UNIQUE REHAU COMPRESSION SLEEVE JOINTING TECHNOLOGY

For hot and cold water applications.



The RAUTITAN system includes a single PN20 pipe system for both hot and cold water, which has been exposed in long-term tests at extreme temperature and pressure conditions to confirm its lifespan of over 50 years even for hot water application.

100% permanent leak-proof

Additional O-rings or other sealants, which can be weak points over the long-term, are not needed because the pipe itself functions as a sealant.

Pressure test up to 150 psi

The RAUTITAN compression sleeve joint is a simple, robust and reliable connection.



EASIER

Engineered for your convenience

RAUTITAN SYSTEM PROVIDES

- Simple, fast and robust jointing technique
- Up to 100m coiled pipe runs. No joint!
- More than 30% less joints per installation
- No waiting for cool down periods before pressurizing the system

One pipe for hot and cold

The RAUTITAN system includes a single PN20 pipe for both hot and cold water applications.

No welding, no brazing!

RAUTITAN's robust 'cold' compression sleeve jointing technology requires no brazing, no welding, no open flames or hot welding tools.



ADVANCED LIGHT WEIGHT MATERIAL AND INNOVATIVE JOINTING TECHNOLOGY

ensure that RAUTITAN is the most convenient and robust plumbing system available.

No deburring
of pipes
required

No scaling!

Inner diameter

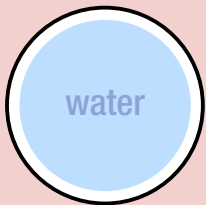

PEX PN20

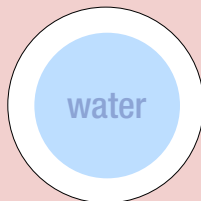

PP-R PN20



Metal with scaling

Due to corrosion and scaling resistant properties, the RAUTITAN system provides the highest standard of hygiene and hydraulic performance, today and in the future.

Reduce workmanship fault

RAUTITAN system can be installed in one single pipe run; no connections; 100% system security!

20% less wastage

RAUTITAN pipes can be cut exactly to the length of the required pipe run.



FASTER

Save time, save cost



RAUTITAN PX fittings

For sizes 16mm to 40mm, non-threaded RAUTITAN fittings, PPSU (polyphenyl sulphone) and compression sleeves, PVDF (polyvinylidene fluoride).

RAUTITAN MX fittings

For sizes 50mm to 63mm high quality Dezincification resistant brass fittings

>30% lesser joints

RAUTITAN PE-Xa pipes give you the freedom to bend around corners and around existing services to complete the installation.

Up to 50% less labour

RAUTITAN's light weight materials and simple jointing process ensure it is a one man job.

OFFERING ALL THE CONDITIONS

for hygienic drinking water distribution



Install a valve with no threaded connection

RAUTITAN valves are featured with unique REHAU compression sleeve connection joints that can create a permanent seal to our RAUTITAN PEX pipes.



100% seamless connection

Unique PEX/PPR adaptors to avoid using threaded connection between the two systems.



TOOLS AND ACCESSORIES

Universal and professional

TWO EASY STEPS TO SECURITY

Making a 100% leak-proof joint has never been this easy. Utilized for over 30 years and across millions of connections REHAU guarantees a 100% permanent leak-proof joint in just two simple steps!

1. Expand the pipe



2. Compress and complete!



RAUTOOL - THE MODULAR TOOL FOR EVERY REQUIREMENT

RAUTOOL
completes
RAUTITAN

Only RAUTOOL assembly tools guarantee easy installation and fully leak-proof connections. Its compact construction simplifies handling and also makes it possible to install in the toughest construction sites. Available in a multitude of modular options, the RAUTOOL program can be tailored to the individual needs of each and every installer.

Simple mechanical design and robust materials ensure long-lasting performance, minimal tool maintenance and regular calibration.



RAUTOOL A-LIGHT2 KOMBI

Combo tool

Dimensions 16 – 40 mm



RAUTOOL M-LIGHT

Compression sleeve joint tool

Dimensions 16 – 20 mm



RAUTOOL G2

Compression sleeve joint tool

Dimensions 40 – 110 mm



SPECIFICATION

Material:	-	PE-Xa
Colour (surface)	-	Black
Notch impact strength at 20°C	-	No fracture
Notch impact strength at -20°C	-	No fracture
Average coefficient of expansion		0.15
When laying with pipe support channel:		
- Size 16 - 40	mm/(mK)	0.04
- Size 50 - 63		0.1
Thermal conductivity	W/(mK)	0.35
Pipe roughness	[mm]	0.007
Operating pressure (maximum at 70°C)	[bar]	10
Operating temperature		
- Maximum	[°C]	90
- Minimum		-
Short-term maximum temperature (malfunction)	[°C]	100
Material constant C	-	12
Minimum bending radius without tools d = pipe diameter	-	8 x d
Minimum bending radius with pipe bend brackets d = pipe diameter	-	3 – 4 x d
Available sizes	[mm]	16 – 63



STANDARD AND CERTIFICATION

BS 6920

Suitability of non-metallic products for use in contact with water intended for human consumption with regard to their effect on the quality of water

BS 7291

Thermoplastics pipes and associated fittings for hot and cold water for domestic purposes and heating installations in buildings

BS EN 1982

Copper and copper alloys. Ingots and castings

BS EN 12163

Copper and copper alloys. Rod for general purposes

BS EN 12165

Copper and copper alloys - Wrought and unwrought forging stock

BS EN 12420

Copper and copper alloys. Forgings

DIN 1988

Codes of practice for drinking water installations (TRWI)

DIN 4102

Fire behaviour of building materials and components

DIN EN 13501

Fire classification of construction products and building elements

DIN EN 12164

Copper and copper alloys - Rod for free machining purposes

DIN EN 12168

Copper and copper alloys - Hollow rod for free machining purposes

DVGW W 291

Cleaning and disinfection of water distribution systems

DVGW W 534

Pipe connectors and connections in the drinking water installation

DVGW W 551

Drinking water heating and drinking water pipe systems

ISO 14001

Environment Management System (EMS) standard

ISO 7

Pipe threads where pressure-tight joints are not made on the threads

ISO 9001

Quality Management Systems

ISO 15875

Plastic piping systems for hot and cold water installations - crosslinked polyethylene (PE-X)

SS 375

Suitability of nonmetallic products for use in contact with water intended for human consumption with regard to their effect on the quality of the water

ISO 50001

Energy Management Systems

QUALITY AND CERTIFICATION

RAUTITAN meets international quality and regulatory standards, and is accredited by both international and national regulation bodies:



RAUTITAN WATER SERVICES PROJECT REFERENCES

Proven for more than 40 years



1 Australia, Federation Square

2 Austria, Power Tower

3 Bulgaria, Primoretz Grand Hotel and Spa

4 Hong Kong, Bel-Air 8

5 Hungary, Ramada Resort Aquaworld

6 Indonesia, JW Marriott Hotel

7 Malaysia, Traders Hotel



8 Netherlands, The Red Apple Apartment
 9 Philippines, Discovery Primea
 10 Russia, Moscow School of Management

11 Slovakia, Wellness Aquamarine
 12 Singapore, W Hotel
 13 South Africa, Radisson Blue Hotel

14 UAE, Hameni Tower JVC DUBAI

RAUTITAN WATER SERVICES

Product range

1.1 Pipes/pipe accessories for drinking water installations

RAUTITAN his

Application: for drinking water installation
 Certification: DVGW-registration number: DVGW DW-8301AG2102 (system approval)
 Feature: building material class: B2 according to DIN 4102-1 or E according to DIN EN 13501-1
 Material: high-pressure cross-linked polyethylen (RAU-PE-Xa) according to DIN EN ISO 15875 and DVGW worksheet W 544
 Colour: natural (white)

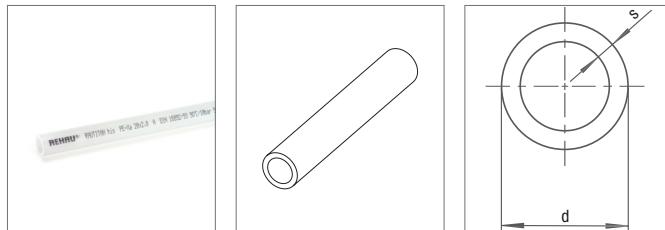

Mat.-no.	description	DN	d	s	volume	weight	packag-
			mm	mm	l/m	g/m	ing unit
11370101100	16 x 2,2	12	16	2.2	0.106	93.7 g/m	100
11370101006	16 x 2,2	12	16	2.2	0.106	93.7 g/m	60
11370201100	20 x 2,8	15	20	2.8	0.163	147.3 g/m	100
11370201006	20 x 2,8	15	20	2.8	0.163	147.3 g/m	60
11370301050	25 x 3,5	20	25	3.5	0.254	231.2 g/m	50
11370301006	25 x 3,5	20	25	3.5	0.254	231.2 g/m	30
11370401050	32 x 4,4	25	32	4.4	0.423	370.3 g/m	50
11370401006	32 x 4,4	25	32	4.4	0.423	370.2 g/m	30
11383201006	40 x 5,5	32	40	5.5	0.661	579 g/m	12
11383301006	50 x 6,9	40	50	6.9	1.03	905.7 g/m	6
11383401006	63 x 8,6	50	63	8.7	1.63	1.422 kg/m	6

Protective pipe

Application: REHAU pipe protection
 Feature:

- as protection against condensation according to DIN 1988, part 200
- as mechanical protection of the radiator connecting pipes, for which there is no requirement to the insulation thickness according to EnEV
- protection in the area of the pipe inlets to the manifold and in the crossing zone of expansion joints in the screed according to DIN 18560
- according to DIN 49019, adjusted for thermal resistance up to +105 °C
- building material class: B2 according to DIN 4102-1 or E according to DIN EN 13501-1

 Material: polyethylene
 Colour: black

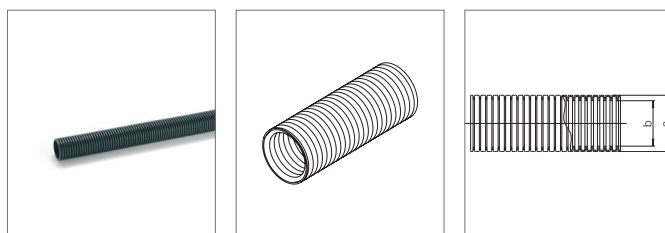

Mat.-no.	description	a	b	delivery length	weight	packag-
		mm	mm	m	g/m	ing unit
11371401050	DN 19, black, f. pipes 16/17, 50 m coil	24	19	50	61	50
11371501050	DN 23, black, f. pipes 20, 50 m coil	28	23	50	97	50
11371601025	DN 29, black, f. pipes 25, 25 m coil	34	29	25	140	25
11371701025	DN 36, black, f. pipes 25, 25 m coil	42	36	25	220	25

Supporting clip channel

Application: to support or to hold installed RAU-PE-Xa-pipes
 Feature: - reduce the temperature related expansion in length of RAU-PE-Xa-pipes
 - self-supporting installation without additional fixing
 - to increase the pipe clamp distance
 - length: 3 m
 Material: galvanized steel

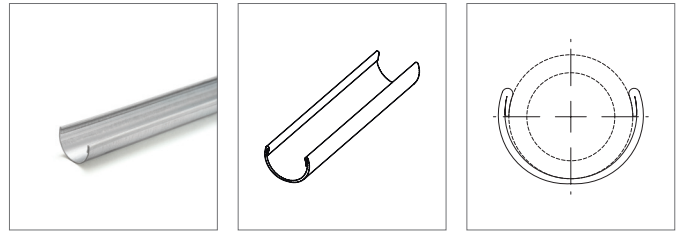

Mat.-no.	description	weight	packag-
		g/m	ing unit
11380331001	for RAU-PE-Xa-pipe 16/17	260	30
11380431001	for RAU-PE-Xa-pipe 20	326	30
11380531001	for RAU-PE-Xa-pipe 25	460	30
11380631001	for RAU-PE-Xa-pipe 32	560	30
11380731001	for RAU-PE-Xa-pipe 40	933	15
11380831001	for RAU-PE-Xa-pipe 50	1120	15
11380931001	for RAU-PE-Xa-pipe 63	1347	15

1.2 Universal compression sleeves and fittings RAUTITAN for drinking water systems systems

Compression sleeve RAUTITAN PX

Application: - to install the permanently tight connection technology compression sleeve according to DVGW-worksheet W 534
 - in combination with the pipes RAUTITAN stabil, RAUTITAN flex and RAUTITAN his with suitable fittings RAUTITAN
 - also useable with RAUGEO polymer fitting and RAUGEO tube green and collect

Feature: usable on both sides

Material: PVDF

Colour: black

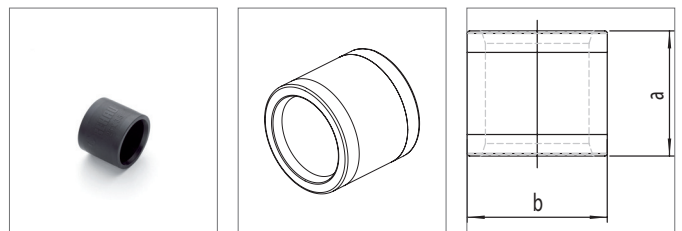

Mat.-no.	description	type	a	b	weight	packag-
			mm	mm	g/Piece	ing unit
11600011001	16	PX	24	24	7.6	100
11600021001	20	PX	25	28	11	100
11600031001	25	PX	27	33	15.82	100
11600041001	32	PX	34	41	28	50
11600051001	40	PX	37	50	38.61	25

Compression sleeve RAUTITAN MX

Application: - to install the permanently tight connection technology compression sleeve according to DVGW-worksheet W 534

- in combination with the universal pipe RAUTITAN stabil, RAUTITAN flex and RAUTITAN his, RAUPEX, RAUTHERM, RAUTHERMEX and RAUTHERMEX strong pipes SDR 7,4 with suitable fittings

Material: standard brass according to DIN EN 12164, DIN EN 12165, DIN EN 12168

Colour: brass blank

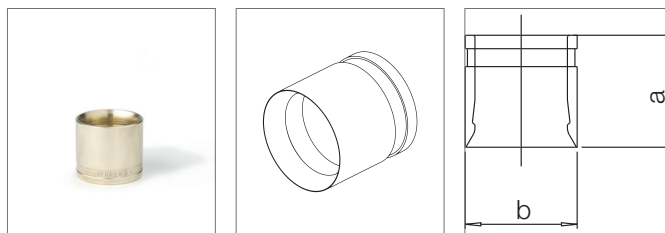

Mat.-no.	description	type	a	b	weight kg/St	packag- ing unit Piece
			mm	mm		
11397711002	50	MX	44	61	0.293	25
11397811002	63	MX	53	74	0.439	25

T-piece RAUTITAN PX

Application: - universal for drinking water and heating installation
- suitable for REHAU pipes: RAUTITAN stabil, RAUTITAN flex, RAUTITAN his

Feature: with tool location tabs

Material: PPSU

Colour: black

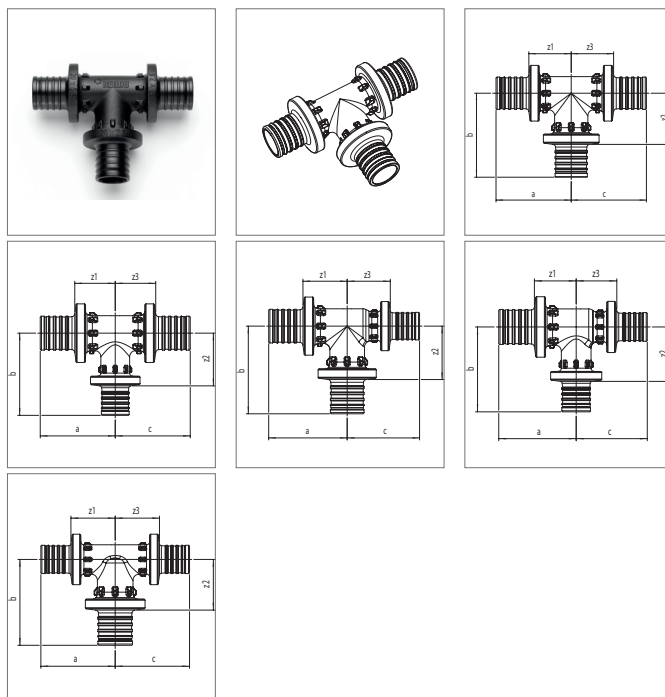

Mat.-no.	description	type	a	b	c	z ₁	z ₂	z ₃	weight g/Piece	packag- ing unit Piece
			mm	mm	mm	mm	mm	mm		
11600311001	16 - 16 - 16	PX	34	38	34	19	24	19	15.5	10
11600321001	20 - 20 - 20	PX	39	43	39	22	26	22	25.15	10
11600331001	25 - 25 - 25	PX	48	53	48	25	30	25	42.6	10
11600341001	32 - 32 - 32	PX	60	65	60	29	35	29	75.9	3
11600351001	40 - 40 - 40	PX	69	75	69	37	43	37	141.6	2
11600611001	20 - 16 - 20	PX	37	40	37	20	26	20	21.6	10
11600621001	25 - 16 - 25	PX	43	43	43	20	29	20	31.6	10
11600631001	25 - 20 - 25	PX	45	46	45	22	29	22	36.3	10
11600641001	32 - 16 - 32	PX	52	47	52	21	32	21	51.4	3
11600651001	32 - 20 - 32	PX	54	50	54	23	32	23	55.7	3
11600661001	32 - 25 - 32	PX	57	56	57	25	33	25	62	3
11600671001	40 - 20 - 40	PX	59	57	59	27	40	27	93.2	2

Mat.-no.	description	type	a	b	c	z ₁	z ₂	z ₃	weight	packag-
			mm	mm	mm	mm	mm	mm	mm	g/Piece
11600681001	40 - 25 - 40	PX	61	64	61	29	41	29	101.4	2
11600691001	40 - 32 - 40	PX	65	73	65	33	41	33	115.1	2
11600711001	20 - 20 - 16	PX	39	43	36	22	26	22	22.6	10
11600721001	25 - 25 - 16	PX	48	53	38	25	30	24	35.3	10
11600731001	25 - 25 - 20	PX	48	53	41	25	30	24	37.7	10
11600741001	32 - 32 - 20	PX	60	65	45	29	34	28	61.24	3
11600751001	32 - 32 - 25	PX	60	65	51	29	34	28	65.8	3
11600811001	20 - 16 - 16	PX	37	40	34	20	26	19	19.2	10
11600821001	25 - 16 - 16	PX	43	43	34	20	29	20	25.1	10
11600831001	25 - 16 - 20	PX	43	43	37	20	29	19	27.6	10
11600841001	25 - 20 - 16	PX	45	46	36	22	29	21	28.7	10
11600851001	25 - 20 - 20	PX	45	46	39	22	29	22	31.1	10
11600861001	32 - 20 - 20	PX	54	50	39	23	33	22	42.8	3
11600871001	32 - 20 - 25	PX	54	50	45	23	33	22	47.1	3
11600891001	32 - 25 - 20	PX	57	56	41	25	33	24	49.7	3
11600911001	32 - 25 - 25	PX	57	56	48	25	33	25	53.4	3
11600921001	40 - 32 - 32	PX	65	73	62	33	41	31	98.6	2
11601011001	16 - 20 - 16	PX	36	41	36	21	24	21	19.1	10
11601021001	16 - 25 - 16	PX	38	48	38	24	25	24	24.8	10
11601031001	20 - 25 - 16	PX	41	50	38	24	27	24	28.6	10
11601041001	20 - 25 - 20	PX	41	50	41	24	27	24	31.1	10
11601061001	25 - 32 - 25	PX	51	62	51	28	30	28	54.4	3

T-piece RAUTITAN RX

Application: - universal for drinking water and heating installation
- suitable for REHAU pipes: RAUTITAN stabil, RAUTITAN flex, RAUTITAN his

Material: red brass
Colour: red brass blank

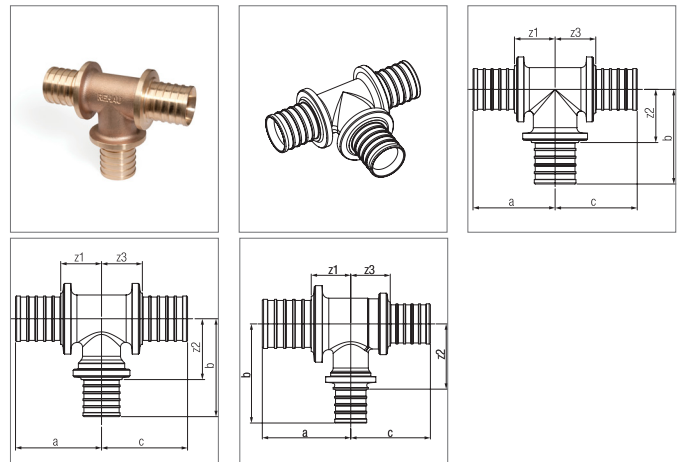

Mat.-no.	description	type	a	b	c	z ₁	z ₂	z ₃	weight	packag-
			mm	mm	mm	mm	mm	mm	mm	kg/St
13660011001	50 - 50 - 50	RX	77	89	77	38	50	38	1.166	1
13660021001	63 - 63 - 63	RX	94	104	94	48	58	48	1.901	1
13660031001	50 - 20 - 50	RX	66	63	66	27	47	27	0.757	1
13660041001	50 - 25 - 50	RX	68	71	68	29	48	29	0.805	1
13660051001	50 - 32 - 50	RX	70	79	70	31	52	31	0.885	1
13660061001	50 - 40 - 50	RX	74	84	74	35	52	35	1.046	1
13660081001	63 - 25 - 63	RX	80	75	80	34	52	34	1.255	1
13660091001	63 - 32 - 63	RX	81	86	81	35	59	35	1.335	1
13660101001	63 - 40 - 63	RX	83	95	83	37	63	37	1.504	1
13660111001	63 - 50 - 63	RX	89	94	89	43	55	43	1.639	1
13660121001	50 - 32 - 40	RX	70	79	64	31	52	32	0.793	1

Bend-T-piece RAUTITAN RX

Application: - universal for drinking water and heating installation
 - suitable for REHAU pipes: RAUTITAN stabil, RAUTITAN flex, RAUTITAN his

Material: red brass
 Colour: red brass blank

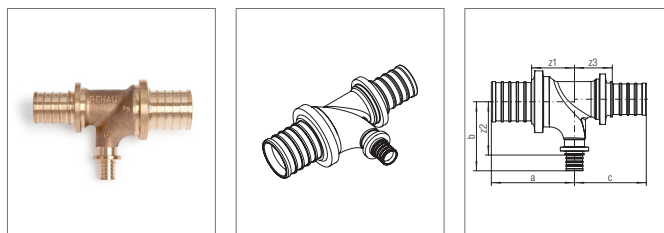

Mat.-no.	description	type	a	b	c	z ₁	z ₂	z ₃	weight g/Piece	packag- ing unit Piece
			mm	mm	mm	mm	mm	mm		
13662751001	32 - 16 - 25	RX	54	48	54	27	36	31	272	1
13662761001	40 - 16 - 32	RX	59	52	59	27	40	32	448	1
13662771001	40 - 20 - 32	RX	59	57	59	27	40	32	461	1

T-piece RAUTITAN RX, with external thread

Application: - universal for drinking water and heating installation
 - suitable for REHAU pipes: RAUTITAN stabil, RAUTITAN flex, RAUTITAN his
 - especially suitable for the connection of flush valves in series and ring lines

Material: red brass
 Colour: red brass blank

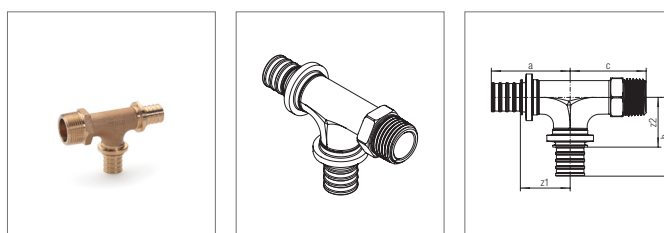

Mat.-no.	description	type	a	b	c	z ₁	z ₂	weight kg/St	packag- ing unit Piece
			mm	mm	mm	mm	mm		
13662791001	16 - 16 - R 1/2	RX	40	40	40	28	28	0.135	4
13662801001	20 - 20 - R 1/2	RX	45	45	43	28	28	0.171	4
13662811001	20 - 20 - R 3/4	RX	45	45	45	28	28	0.188	4

Wall-T-piece RAUTITAN RX, outlet with internal thread

Application: - universal for drinking water and heating installation
 - suitable for REHAU pipes: RAUTITAN stabil, RAUTITAN flex, RAUTITAN his

Feature: with mounting option
 Material: red brass
 Colour: red brass blank

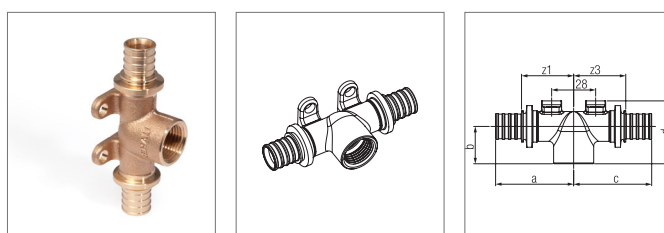

Mat.-no.	description	type	a	b	c	z ₁	z ₃	weight kg/St	packag- ing unit Piece
			mm	mm	mm	mm	mm		
13660161001	16 - Rp 1/2 - 16	RX	46	26	46	34	34	0.154	10
13660171001	20 - Rp 1/2 - 16	RX	49	24	49	33	33	0.18	10
13660181001	20 - Rp 1/2 - 20	RX	50	24	50	34	34	0.177	10

T-piece RAUTITAN RX, outlet with internal thread

Application: - universal for drinking water and heating installation
 - suitable for REHAU pipes: RAUTITAN stabil, RAUTITAN flex, RAUTITAN his

Material: red brass
 Colour: red brass blank

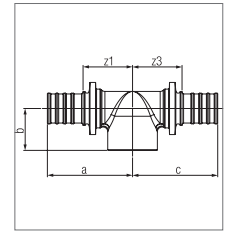
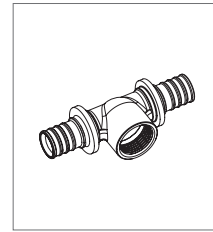

Mat.-no.	description	type	a	b	c	z ₁	z ₃	weight	packag- ing unit
			mm	mm	mm	mm	mm	kg/St	Piece
13662971001	25 - Rp 1/2 - 25	RX	51	26	51	28	28	0.189	10
13660201001	25 - Rp 3/4 - 25	RX	55	27	55	32	32	0.216	10
13660241001	32 - Rp 3/4 - 25	RX	58	30	58	31	30	0.277	3
13660211001	32 - Rp 3/4 - 32	RX	61	30	61	34	34	0.327	3
13660261001	32 - Rp 1 - 32	RX	65	33	65	38	38	0.387	3
13660281001	40 - Rp 1 - 40	RX	69	35	69	37	37	0.645	1
13660311001	50 - Rp 1 - 50	RX	77	39	77	38	38	0.859	1

Coupling RAUTITAN PX

Application: - universal for drinking water and heating installation
 - suitable for REHAU pipes: RAUTITAN stabil, RAUTITAN flex, RAUTITAN his

Feature: with tool location tabs
 Material: PPSU
 Colour: black

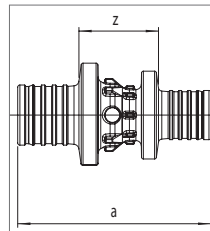
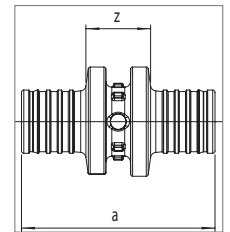
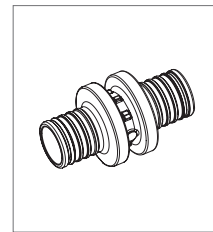

Mat.-no.	description	type	a	z	weight	packag- ing unit
			mm	mm	g/Piece	Piece
11600111001	16 - 16	PX	45	16	7.9	10
11600121001	20 - 20	PX	51	17	12.7	10
11600131001	25 - 25	PX	64	18	20.7	10
11600141001	32 - 32	PX	82	20	37.7	10
11600151001	40 - 40	PX	88	24	68.2	4
11600411001	20 - 16	PX	53	22	11.1	10
11600421001	25 - 16	PX	63	26	16.5	10
11600431001	25 - 20	PX	65	25	18.8	10
11600441001	32 - 25	PX	84	30	33.6	10
11600471001	40 - 32	PX	100	37	60.9	4

Coupling RAUTITAN RX

Application: - universal for drinking water and heating installation
 - suitable for REHAU pipes: RAUTITAN stabil, RAUTITAN flex, RAUTITAN his

Material: red brass
 Colour: red brass blank

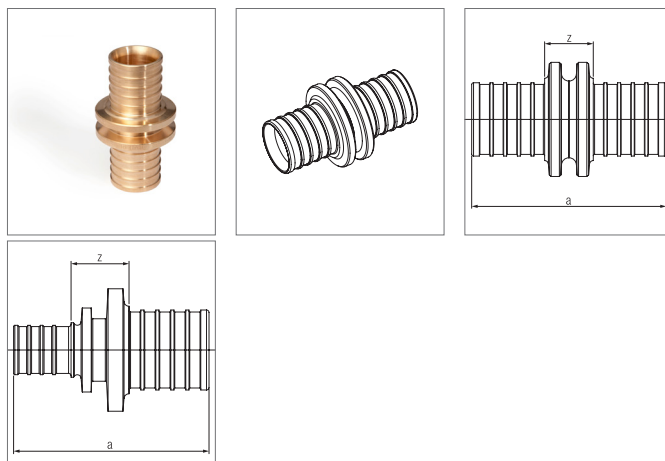

Mat.-no.	description	type	a	z	weight kg/St	packag- ing unit Piece
			mm	mm		
13660341001	50 - 50	RX	104	26	0.592	1
13660361001	63 - 63	RX	125	33	0.998	1
13662601001	40 - 25	RX	72	17	0.247	5
13660391001	50 - 32	RX	91	25	0.382	5
13660411001	50 - 40	RX	97	26	0.483	1
13660431001	63 - 50	RX	115	30	0.813	1

Elbow RAUTITAN PX

Application: - universal for drinking water and heating installation
 - suitable for REHAU pipes: RAUTITAN stabil, RAUTITAN flex, RAUTITAN his

Feature: with tool location tabs
 Material: PPSU
 Colour: black

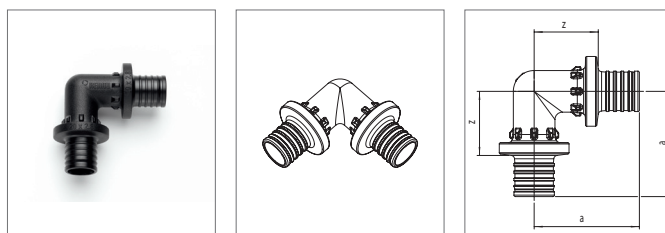

Mat.-no.	description	angel	type	a	z	weight g/Piece	packag- ing unit Piece
		°		mm	mm		
11600211001	16 - 16, 90 degree	90	PX	38	24	11.7	10
11600221001	20 - 20, 90 degree	90	PX	43	26	18.5	10
11600231001	25 - 25, 90 degree	90	PX	53	30	31.3	10
11600241001	32 - 32, 90 degree	90	PX	65	34	55.5	3
11600251001	40 - 40, 90 degree	90	PX	75	43	104.6	3

Bend RAUTITAN RX

Application: - universal for drinking water and heating installation
 - suitable for REHAU pipes: RAUTITAN stabil, RAUTITAN flex, RAUTITAN his

Material: red brass
 Colour: red brass blank

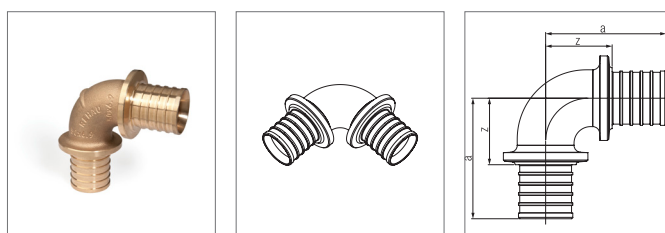

Mat.-no.	description	angel	type	a	z	weight	packaging unit
		°		mm	mm	kg/St	Piece
13660441001	50 - 50, 90 degree	90	RX	87	48	0.854	1
13660461001	63 - 63, 90 degree	90	RX	106	60	1.365	1

Elbow RAUTITAN PX

Application: - universal for drinking water and heating installation
 - suitable for REHAU pipes: RAUTITAN stabil, RAUTITAN flex, RAUTITAN his

Feature: with tool location tabs

Material: PPSU

Colour: black

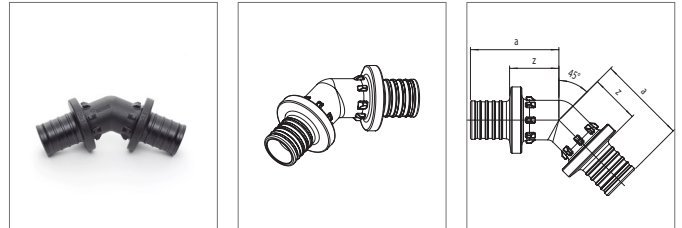

Mat.-no.	description	angel	type	a	z	weight	packaging unit
		°		mm	mm	g/Piece	Piece
11600521001	20 - 20, 45 degree	45	PX	38	21	16.9	10
11600531001	25 -25, 45 degree	45	PX	46	23	28.1	10
11600541001	32 - 32, 45 degree	45	PX	60	28	51.5	3
11600551001	40 - 40, 45 degree	45	PX	66	34	93.1	2

Bend RAUTITAN RX

Application: - universal for drinking water and heating installation
 - suitable for REHAU pipes: RAUTITAN stabil, RAUTITAN flex, RAUTITAN his

Material: red brass

Colour: red brass blank

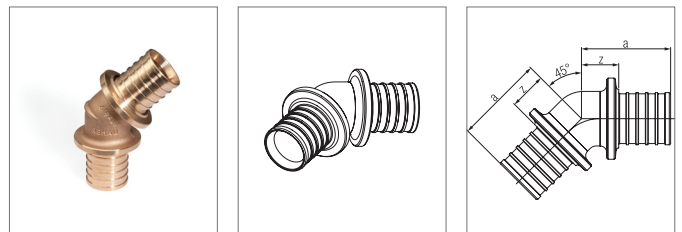

Mat.-no.	description	angel	type	a	z	weight	packaging unit
		°		mm	mm	kg/St	Piece
13660471001	50 - 50, 45 degree	45	RX	67	28	0.725	1
13660481001	63 - 63, 45 degree	45	RX	80	34	1.193	1

Pipe bend former sanitary, 90°

Feature: consisting of elbow plate and 2 clamping sleeve

Material: galvanized steel

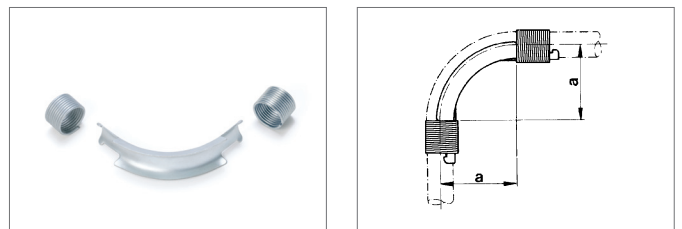

Mat.-no.	description	angel	a	weight	packaging unit
		°	mm	g/Piece	Piece
11388811002	16, 90 degree	90	48	55	10
11388911002	20, 90 degree	90	60	60	10
11383511002	25, 90 degree	90	75	150	10
11386411002	32, 90 degree	90	128	310	5

Pipe bend former sanitary, 45°

Feature: consisting of elbow plate and 2 clamping sleeve
 Material: galvanized steel

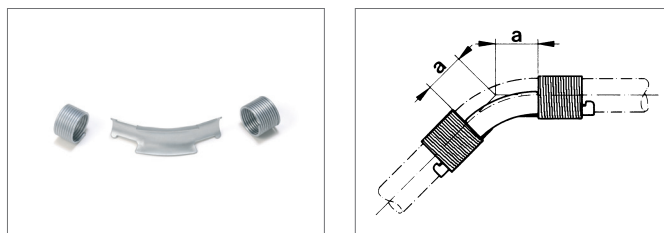

Mat.-no.	description	angel	a	weight	packag-
		°	mm	g/Piece	ing unit
11391211002	16, 45 degree	45	20	40	10
11391311002	20, 45 degree	45	25	45	10
11389111002	25, 45 degree	45	31	120	10
11389211002	32, 45 degree	45	40	210	5

Adapter RAUTITAN RX, with external thread

Application: - universal for drinking water and heating installation
 - suitable for REHAU pipes: RAUTITAN stabil, RAUTITAN flex, RAUTITAN his

Material: red brass
 Colour: red brass blank

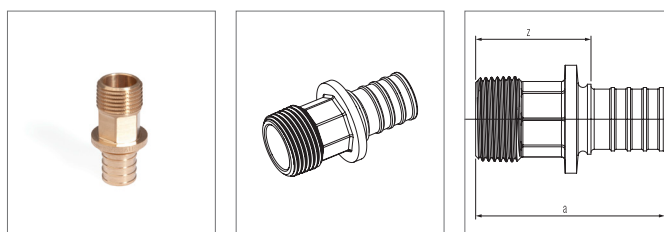

Mat.-no.	description	type	a	z	weight	packag-
			mm	mm	kg/St	ing unit
13660491001	16 - R 1/2	RX	45	32	0.05	10
13660501001	16 - R 3/4	RX	46	34	0.072	10
13660511001	16 - R 1	RX	48	36	0.105	5
13660521001	20 - R 1/2	RX	50	33	0.059	10
13660531001	20 - R 3/4	RX	51	34	0.074	10
13660551001	20 - R 1	RX	53	36	0.113	5
13660561001	25 - R 1/2	RX	56	33	0.088	10
13660571001	25 - R 3/4	RX	59	36	0.102	10
13660581001	25 - R 1	RX	61	38	0.132	10
13660591001	32 - R 3/4	RX	65	38	0.146	10
13660601001	32 - R 1	RX	67	40	0.16	10
13660611001	32 - R 1 1/4	RX	71	44	0.211	5
13660621001	40 - R 1 1/4	RX	78	46	0.325	5
13660631001	50 - R 1 1/4	RX	84	45	0.431	5
13660651001	50 - R 1 1/2	RX	84	45	0.468	1
13660661001	63 - R 2	RX	100	54	0.76	1

Adapter RAUTITAN RX, with internal thread

Application: - universal for drinking water and heating installation
 - suitable for REHAU pipes: RAUTITAN stabil, RAUTITAN flex, RAUTITAN his

Material: red brass
 Colour: red brass blank

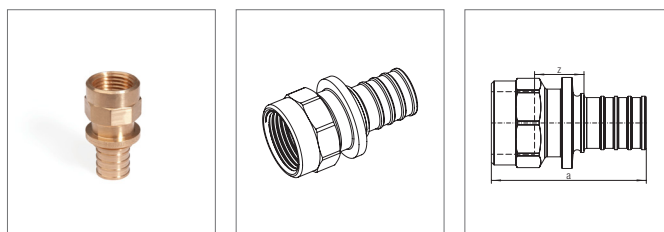

Mat.-no.	description	type	a	z	weight	packag-
			mm	mm	kg/St	ing unit
13660671001	16 - Rp 1/2	RX	44	17	0.056	10
13660681001	20 - Rp 1/2	RX	47	16	0.067	10
13660691001	20 - Rp 3/4	RX	50	18	0.086	10
13660701001	25 - Rp 1/2	RX	49	11	0.082	10
13660711001	25 - Rp 3/4	RX	57	18	0.11	10
13662891001	25 - Rp 1	RX	62	20	0.153	5
13660721001	32 - Rp 3/4	RX	54	11	0.124	10
13660731001	32 - Rp 1	RX	67	21	0.188	10
13660741001	40 - Rp 1 1/4	RX	75	22	0.354	5

Adapter RAUTITAN RX, with screwcap

Application: - universal for drinking water and heating installation
- suitable for REHAU pipes: RAUTITAN stabil, RAUTITAN flex, RAUTITAN his

Material: red brass
Colour: red brass blank

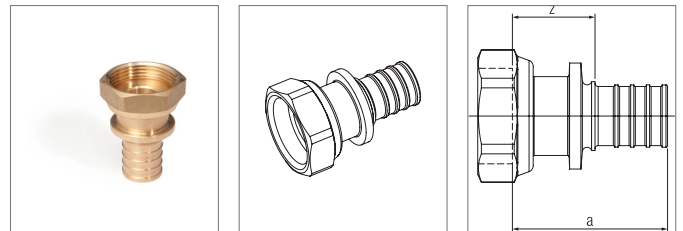

Mat.-no.	description	type	a	z	weight	packag-
			mm	mm	kg/St	ing unit
13660751001	16 - G 1/2	RX	32	20	0.057	10
13660761001	16 - G 3/4	RX	34	21	0.069	10
13660771001	20 - G 1/2	RX	42	25	0.076	10
13660781001	20 - G 3/4	RX	38	22	0.081	10
13660791001	25 - G 3/4	RX	52	29	0.116	10
13660801001	25 - G 1	RX	49	26	0.145	10
13660811001	32 - G 1	RX	55	28	0.19	10
13660821001	32 - G 1 1/4	RX	55	28	0.238	5
13660831001	32 - G 1 1/2	RX	52	25	0.244	5
13660841001	40 - G 1 1/2	RX	60	28	0.362	1
13660861001	50 - G 1 3/4	RX	67	28	0.522	1
13660871001	63 - G 2 3/8	RX	82	36	0.822	1

Sold press adapter RAUTITAN RX

Application: - transition from system RAUTIAN to soldering and metall-press-system according DVGW worksheet W 534
- universal for drinking water and heating installation
- suitable for REHAU pipes: RAUTITAN stabil, RAUTITAN flex, RAUTITAN his

Material: red brass
Colour: red brass blank

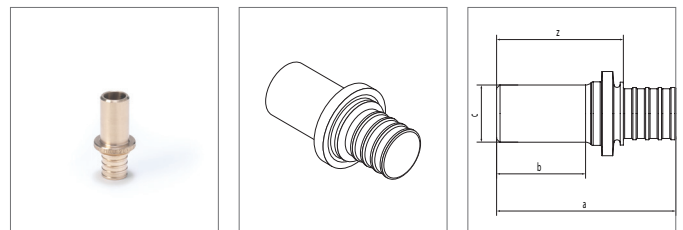

Mat.-no.	description	type	a	b	c	z	weight	packag-
			mm	mm	mm	mm	g/Piece	ing unit
11372061001	16 - L 15	RX	53	30	15	40	40	2
12871931001	20 - L 15	RX	57	27	15	41	57	2

Mat.-no.	description	type	a	b	c	z	weight	packaging unit
			mm	mm	mm	mm	g/Piece	Piece
11372161001	20 - L 18	RX	53	30	18	37	60	2
11375061001	20 - L 22	RX	62	32	22	45	72	2
12196741001	20 - L 28	RX	61	32	28	45	95	2
11372261001	25 - L 22	RX	68	31	22	45	94	2
12871961001	25 - L 28	RX	69	32	28	46	117	2
11372361001	32 - L 28	RX	75	38	28	48	148	2

Elbow adapter RAUTITAN RX, with external thread

Application: - universal for drinking water and heating installation
- suitable for REHAU pipes: RAUTITAN stabil, RAUTITAN flex, RAUTITAN his

Material: red brass
Colour: red brass blank

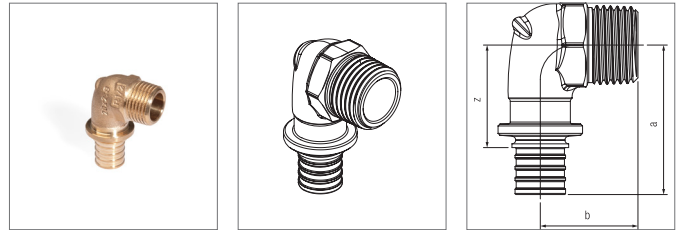

Mat.-no.	description	type	a	b	z	weight	packaging unit
			mm	mm	mm	kg/St	Piece
13660881001	16 - R 1/2	RX	40	26	28	0.078	10
13660891001	20 - R 1/2	RX	42	28	26	0.089	10
13660901001	20 - R 3/4	RX	44	28	28	0.108	10
13660911001	25 - R 3/4	RX	52	31	29	0.144	10
13660921001	32 - R 3/4	RX	60	34	33	0.206	3
13660931001	32 - R 1	RX	64	37	37	0.249	3

Elbow adapter RAUTITAN RX, with internal thread

Application: - universal for drinking water and heating installation
- suitable for REHAU pipes: RAUTITAN stabil, RAUTITAN flex, RAUTITAN his

Material: red brass
Colour: red brass blank

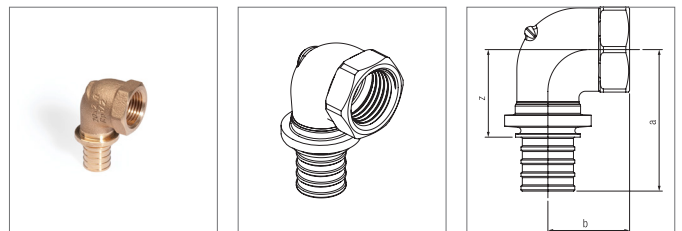

Mat.-no.	description	type	a	b	z	weight	packaging unit
			mm	mm	mm	kg/St	Piece
13660941001	16 - Rp 1/2	PX	42	24	30	0.093	10
13660951001	16 - Rp 3/4	PX	44	24	32	0.12	10
13660961001	20 - Rp 1/2	PX	44	25	27	0.103	10
13660971001	20 - Rp 3/4	PX	47	25	31	0.119	10
13660981001	25 - Rp 1	PX	59	31	36	0.219	10

Elbow adapter RAUTITAN RX, with screwcap

Application: - universal for drinking water and heating installation
- suitable for REHAU pipes: RAUTITAN stabil, RAUTITAN flex, RAUTITAN his

Material: red brass
Colour: red brass blank

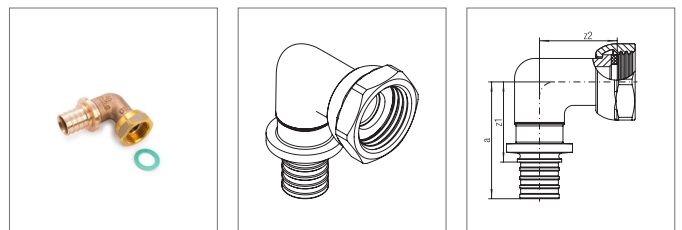

Flange wall-mounted elbow RAUTITAN RX

Application: - for wall termination box (Mat. Nr. 11370351001), with 2 screws made of stainless steel
 - universal for drinking water and heating installation
 - suitable for REHAU pipes: RAUTITAN stabil, RAUTITAN flex, RAUTITAN his

Material: red brass

Colour: red brass blank

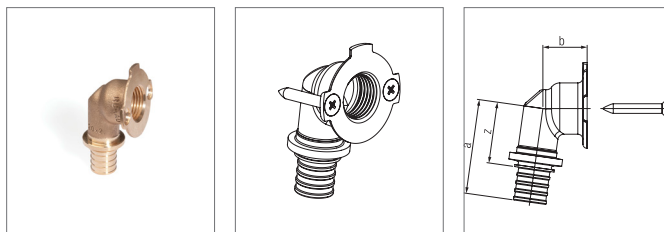

Mat.-no.	description	a	b	z	weight	packag- ing unit
		mm	mm	mm	kg/St	Piece
13661261001	16 - Rp 1/2	42	22	30	0.094	10
13661271001	20 - Rp 1/2	47	23	31	0.109	10

Wall termination box

Application: - for flange wall-mounted elbow RAUTITAN RX, with 2 socket head screws made of galvanized steel to fix on the bracket O 75/150 for wall connection box
 - for inclusion of RAUTITAN stabil, flex and his pipes in protective pipes

Material: polyoxymethylene

Colour: black

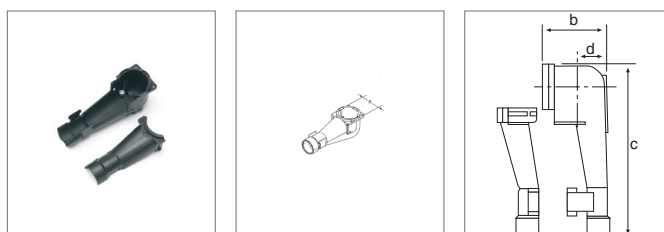

Mat.-no.	description	a	b	c	d	weight	packag- ing unit
		mm	mm	mm	mm	g/Piece	Piece
11370351001	2-parts	48	48	138	137.5	61.6	2

Compression sleeve manifold RAUTITAN RX, 2-port

Application: - universal for drinking water and heating installation
 - suitable for REHAU pipes: RAUTITAN stabil, RAUTITAN flex, RAUTITAN his

Material: red brass
 Colour: red brass blank

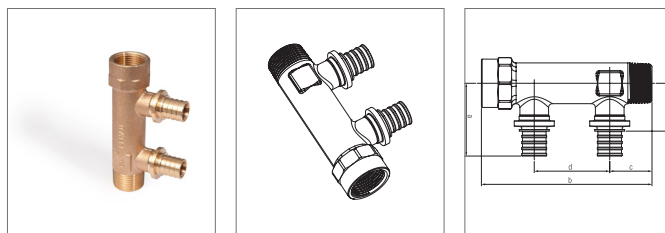

Mat.-no.	description	type	a	b	c	d	z	weight	packag-
			mm	mm	mm	mm		mm	kg/St
13661281001	2-port, 16 - R/Rp 3/4	RX	43	113	28	50	31	0.302	Piece
13661301001	2-port, 20 - R/Rp 3/4	RX	48	113	28	50	32	0.331	Piece

Compression sleeve manifold RAUTITAN RX, 3-port

Application: - universal for drinking water and heating installation
 - suitable for REHAU pipes: RAUTITAN stabil, RAUTITAN flex, RAUTITAN his

Material: red brass
 Colour: red brass blank

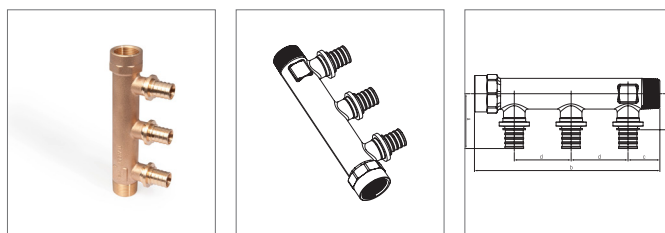

Mat.-no.	description	type	a	b	c	d	z	weight	packag-
			mm	mm	mm	mm		mm	kg/St
13661311001	3-port, 16 - R/Rp 3/4	RX	43	163	28	50	31	0.451	Piece
13661321001	3-port, 20 - R/Rp 3/4	RX	43	163	28	50	32	0.474	Piece

Dummy plug RAUTITAN RX

Application: - universal for drinking water and heating installation
 - suitable for REHAU pipes: RAUTITAN stabil, RAUTITAN flex, RAUTITAN his

Material: red brass
 Colour: red brass blank

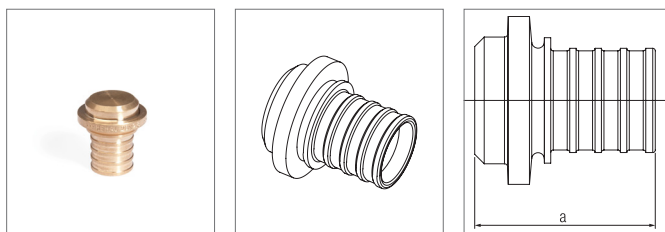

Mat.-no.	description	a	weight	packag-
			mm	kg/St
13661391001	16	24	0.025	Piece
13661401001	20	28	0.041	Piece

Cap RAUTITAN RX

Application: to close connections with external thread R1/2 or R3/4

Material: red brass
 Colour: red brass blank

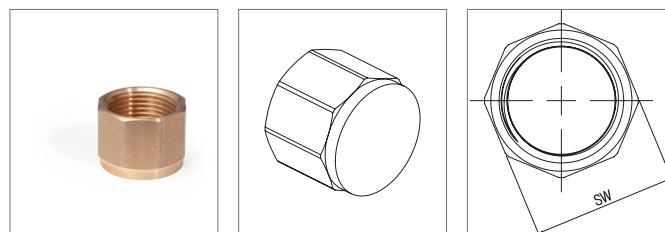

Mat.-no.	description	weight	packag-
		kg/St	ing unit
13661431001	Rp 1/2	0.044	Piece
13661441001	Rp 3/4	0.065	Piece

This document is protected by copyright. All rights based on this are reserved. No part of this publication may be translated, reproduced or transmitted in any form or by any similar means, electronic or mechanical, photocopying, recording or otherwise, or stored in a data retrieval system.

Our verbal and written advice with regard to usage is based on years of experience and standardised assumptions and is provided to the best of our knowledge. The intended use of REHAU products is described comprehensively in the technical product information. The latest version can be viewed at www.rehau.com/TI. We have no control over the application, use or processing of the products. Responsibility for these activities therefore remains entirely with the respective user/processor.

Where claims for liability nonetheless arise, they shall be governed exclusively according to our terms and conditions, available at www.rehau.com/conditions, insofar as nothing else has been agreed upon with REHAU in writing. This shall also apply for all warranty claims, with the warranty applying to the consistent quality of our products in accordance with our specifications. Subject to technical changes.

© REHAU AG + Co
Rheniumhaus
95111 Rehau
www.rehau.de

Errors and changes excepted.
DH100449 EN TYP 04.2017